

**Rectifier diodes
schottky barrier**

PBYR745X series

GENERAL DESCRIPTION

Low leakage, platinum barrier, schottky rectifier diodes in a full pack plastic envelope featuring low forward voltage drop, absence of stored charge, and guaranteed reverse surge capability. The devices are intended for use in switched mode power supplies and high frequency circuits in general where low conduction and zero switching losses are important.

QUICK REFERENCE DATA

SYMBOL	PARAMETER	MAX.	MAX.	MAX.	UNIT
V_{RRM}	PBYR7- Repetitive peak reverse voltage Forward voltage Average forward current	35X 35	40X 40	45X 45	V
V_F		0.57	0.57	0.57	V
$I_{F(AV)}$		7.5	7.5	7.5	A

PINNING - SOD113

PIN	DESCRIPTION
1	cathode
2	anode
case	isolated

PIN CONFIGURATION

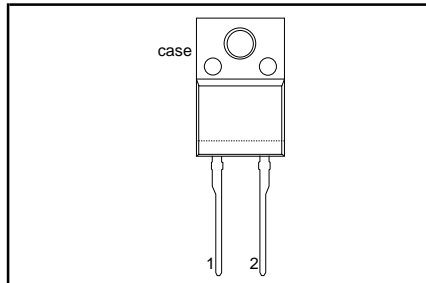

SYMBOL

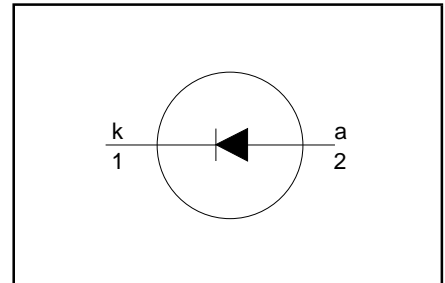

LIMITING VALUES

Limiting values in accordance with the Absolute Maximum System (IEC 134).

SYMBOL	PARAMETER	CONDITIONS	MIN.	MAX.			UNIT
				-35	-40	-45	
V_{RRM}	Repetitive peak reverse voltage	$T_{hs} \leq 128\text{ }^\circ\text{C}$	-	35	40	45	V
V_{RWM}	Crest working reverse voltage		-	35	40	45	V
V_R	Continuous reverse voltage		-	35	40	45	V
$I_{F(AV)}$	Average forward current	square wave; $\delta = 0.5$; $T_{hs} \leq 123\text{ }^\circ\text{C}$	-	7.5			A
$I_{F(RMS)}$	RMS output current	$t = 25\text{ }\mu\text{s}$; $\delta = 0.5$; $T_{hs} \leq 123\text{ }^\circ\text{C}$	-	10.6			A
I_{FRM}	Repetitive peak forward current		-	15			A
I_{FSM}	Non-repetitive peak forward current		$t = 10\text{ ms}$ $t = 8.3\text{ ms}$ sinusoidal $T_j = 125\text{ }^\circ\text{C}$ prior to surge; with reapplied	-	100		
			-	110			A
I^2t	I^2t for fusing	$V_{RRM(max)}$ $t = 10\text{ ms}$	-	50			A ² s
I_{RRM}	Repetitive peak reverse current	$t_p = 2\text{ }\mu\text{s}$; $\delta = 0.001$	-	1			A
I_{RSM}	Non-repetitive peak reverse current	$t_p = 100\text{ }\mu\text{s}$	-	1			A
T_{stg}	Storage temperature		-65	175			$^\circ\text{C}$
T_j	Operating junction temperature		-	150			$^\circ\text{C}$

**Rectifier diodes
schottky barrier**
PBYR745X series
ISOLATION LIMITING VALUE & CHARACTERISTIC
 $T_{hs} = 25\text{ °C}$ unless otherwise specified

SYMBOL	PARAMETER	CONDITIONS	MIN.	TYP.	MAX.	UNIT
V_{isol}	R.M.S. isolation voltage from all three terminals to external heatsink	$f = 50\text{-}60\text{ Hz}$; sinusoidal waveform; R.H. $\leq 65\%$; clean and dustfree	-		2500	V
C_{isol}	Capacitance from T2 to external heatsink	$f = 1\text{ MHz}$	-	10	-	pF

THERMAL RESISTANCES

SYMBOL	PARAMETER	CONDITIONS	MIN.	TYP.	MAX.	UNIT
$R_{th\ j\text{-}hs}$	Thermal resistance junction to heatsink	with heatsink compound	-	-	5.5	K/W
$R_{th\ j\text{-}a}$	Thermal resistance junction to ambient	in free air.	-	55	-	K/W

STATIC CHARACTERISTICS
 $T_j = 25\text{ °C}$ unless otherwise stated

SYMBOL	PARAMETER	CONDITIONS	MIN.	TYP.	MAX.	UNIT
V_F	Forward voltage	$I_F = 7.5\text{ A}$; $T_j = 125\text{ °C}$ $I_F = 15\text{ A}$; $T_j = 125\text{ °C}$	-	0.50 0.62	0.59 0.72	V V
I_R	Reverse current	$I_F = 15\text{ A}$ $V_R = V_{RRM}$	-	0.78 50	0.84 100	V μA
C_d	Junction capacitance	$V_R = V_{RRM}$; $T_j = 125\text{ °C}$ $f = 1\text{ MHz}$; $V_R = 5\text{ V}$; $T_j = 25\text{ °C}$ to 125 °C	-	13 350	22 -	mA pF

Rectifier diodes
schottky barrier

PBYR745X series

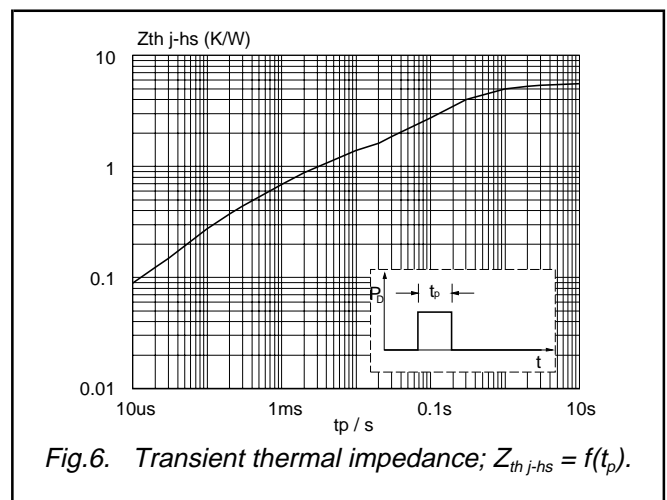
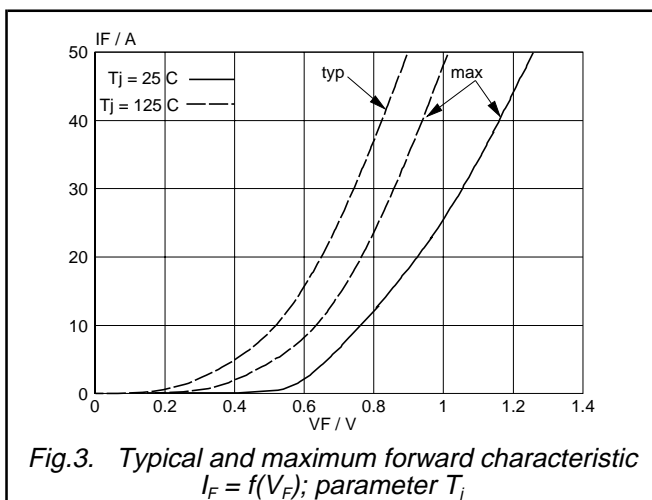
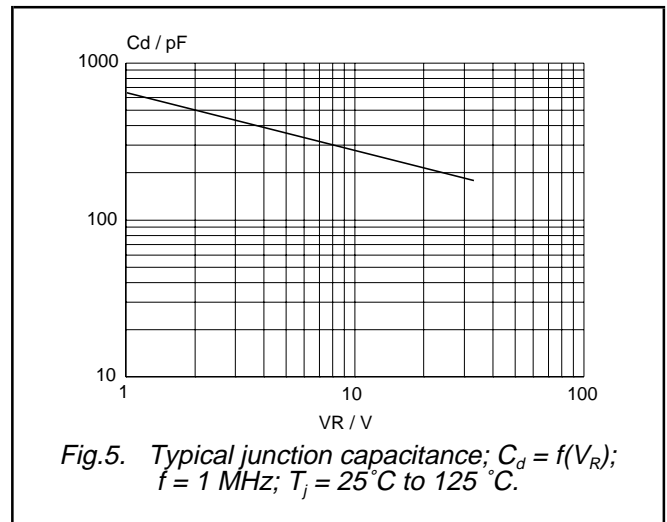
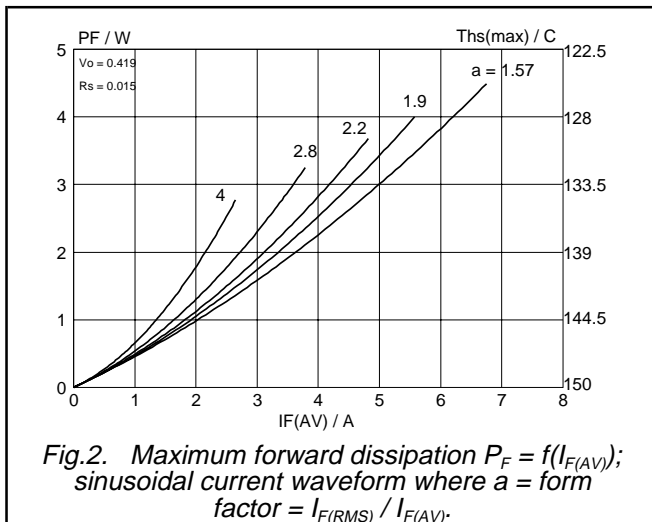
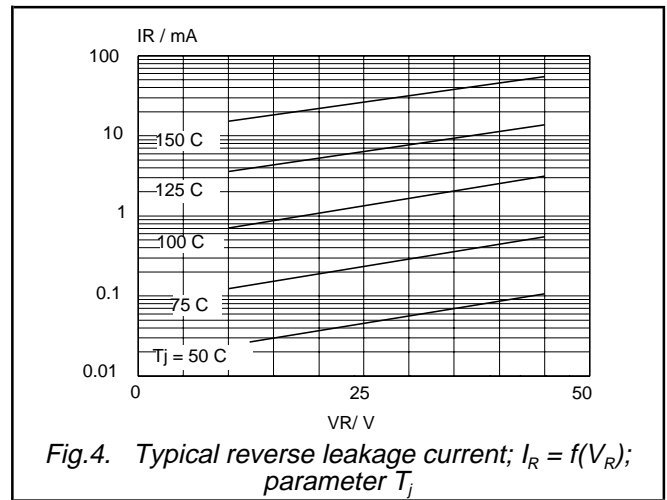
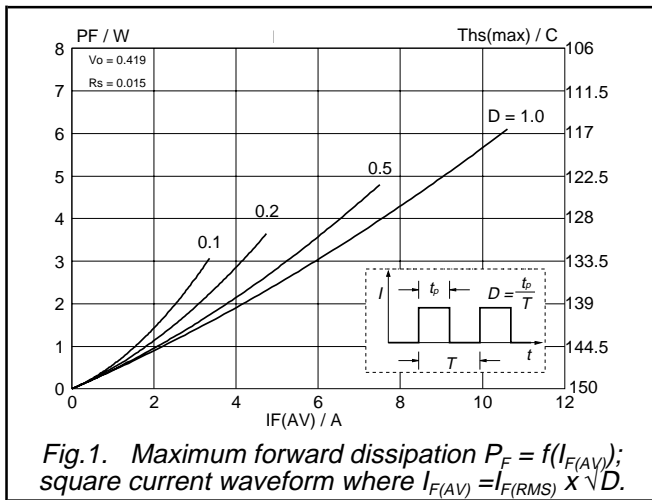

Rectifier diodes
schottky barrier

PBYR745X series

MECHANICAL DATA

Dimensions in mm

Net Mass: 2 g

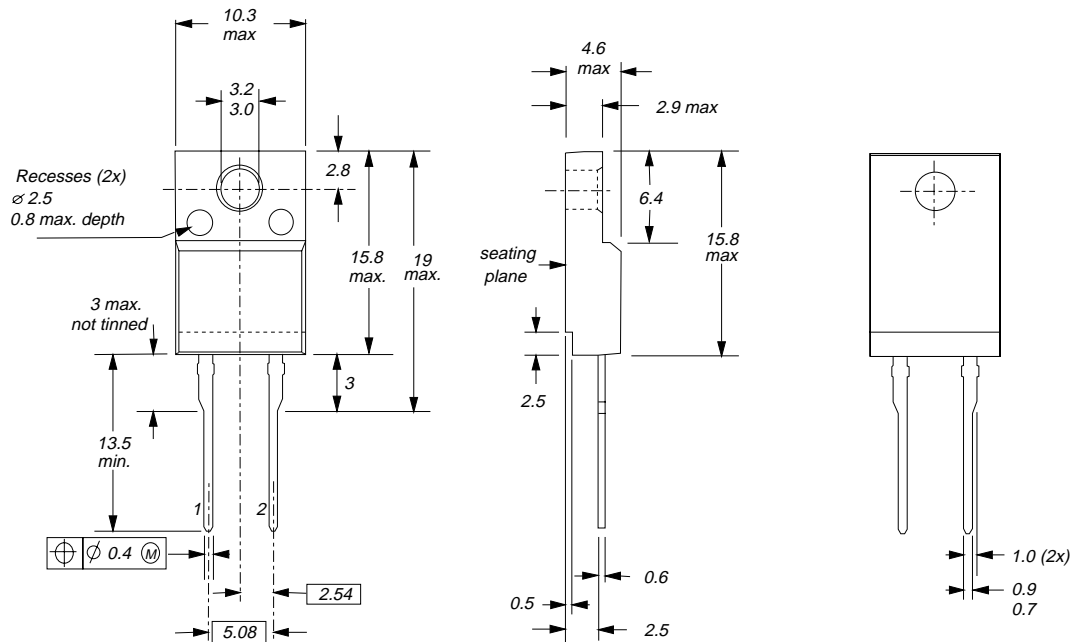

Fig.7. SOD113; The seating plane is electrically isolated from all terminals.

Notes

1. Refer to mounting instructions for F-pack envelopes.
2. Epoxy meets UL94 V0 at 1/8".

**Rectifier diodes
schottky barrier**

PBYR745X series

DEFINITIONS

Data sheet status	
Objective specification	This data sheet contains target or goal specifications for product development.
Preliminary specification	This data sheet contains preliminary data; supplementary data may be published later.
Product specification	This data sheet contains final product specifications.
Limiting values	
Limiting values are given in accordance with the Absolute Maximum Rating System (IEC 134). Stress above one or more of the limiting values may cause permanent damage to the device. These are stress ratings only and operation of the device at these or at any other conditions above those given in the Characteristics sections of this specification is not implied. Exposure to limiting values for extended periods may affect device reliability.	
Application information	
Where application information is given, it is advisory and does not form part of the specification.	
© Philips Electronics N.V. 1997	
All rights are reserved. Reproduction in whole or in part is prohibited without the prior written consent of the copyright owner.	
The information presented in this document does not form part of any quotation or contract, it is believed to be accurate and reliable and may be changed without notice. No liability will be accepted by the publisher for any consequence of its use. Publication thereof does not convey nor imply any license under patent or other industrial or intellectual property rights.	

LIFE SUPPORT APPLICATIONS

These products are not designed for use in life support appliances, devices or systems where malfunction of these products can be reasonably expected to result in personal injury. Philips customers using or selling these products for use in such applications do so at their own risk and agree to fully indemnify Philips for any damages resulting from such improper use or sale.