

**Rectifier diodes
ultrafast**

BYV29 series

GENERAL DESCRIPTION

Glass passivated, high efficiency, rectifier diodes in a plastic envelope featuring low forward voltage drop, ultra fast reverse recovery times and soft recovery characteristic. They are intended for use in switched mode power supplies and high frequency circuits in general, where both low conduction losses and low switching losses are essential.

QUICK REFERENCE DATA

SYMBOL	PARAMETER	MAX.	MAX.	MAX.	UNIT
V_{RRM}	Repetitive peak reverse voltage	300 300	400 400	500 500	V
V_F	Forward voltage	1.03	1.03	1.03	V
$I_{F(AV)}$	Average forward current	9	9	9	A
t_{rr}	Reverse recovery time	60	60	60	ns

PINNING - TO220AC

PIN	DESCRIPTION
1	cathode (k)
2	anode (a)
tab	cathode (k)

PIN CONFIGURATION

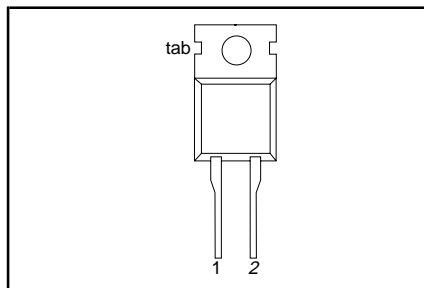

SYMBOL

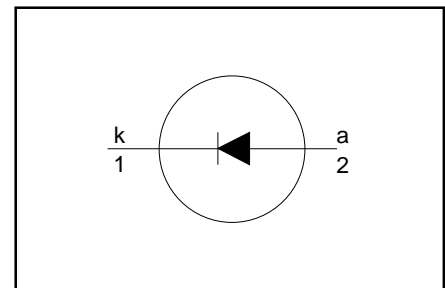

LIMITING VALUES

Limiting values in accordance with the Absolute Maximum System (IEC 134).

SYMBOL	PARAMETER	CONDITIONS	MIN.	MAX.			UNIT
				-300	-400	-500	
V_{RRM}	Repetitive peak reverse voltage		-	300	400	500	V
V_{RWM}	Crest working reverse voltage		-	300	400	500	V
V_R	Continuous reverse voltage		-	300	400	500	V
$I_{F(AV)}$	Average forward current ¹	square wave; $\delta = 0.5$; $T_{mb} \leq 123^\circ\text{C}$	-	9			A
		sinusoidal; $a = 1.57$; $T_{mb} \leq 125^\circ\text{C}$	-	8			A
$I_{F(RMS)}$	RMS forward current		-	13			A
I_{FRM}	Repetitive peak forward current	$t = 25\ \mu\text{s}$; $\delta = 0.5$; $T_{mb} \leq 123^\circ\text{C}$	-	18			A
I_{FSM}	Non-repetitive peak forward current.	$t = 10\ \text{ms}$	-	100			A
		$t = 8.3\ \text{ms}$ sinusoidal; with reapplied	-	110			A
I^2t	I^2t for fusing	$V_{RRM(max)}$ $t = 10\ \text{ms}$	-	50			A ² s
T_{stg}	Storage temperature		-40	150			°C
T_j	Operating junction temperature		-	150			°C

¹ Neglecting switching and reverse current losses.

Rectifier diodes ultrafast

BYV29 series

THERMAL RESISTANCES

SYMBOL	PARAMETER	CONDITIONS	MIN.	TYP.	MAX.	UNIT
$R_{th\ j-mb}$	Thermal resistance junction to mounting base	in free air.	-	-	2.5	K/W
$R_{th\ j-a}$	Thermal resistance junction to ambient		-	60	-	K/W

STATIC CHARACTERISTICS

$T_j = 25\text{ °C}$ unless otherwise stated

SYMBOL	PARAMETER	CONDITIONS	MIN.	TYP.	MAX.	UNIT
V_F	Forward voltage	$I_F = 8\text{ A}; T_j = 150\text{ °C}$	-	0.90	1.03	V
		$I_F = 8\text{ A}$	-	1.05	1.25	V
		$I_F = 20\text{ A}$	-	1.20	1.40	V
I_R	Reverse current	$V_R = V_{RRM}$	-	2.0	50	μA
		$V_R = V_{RRM}; T_j = 100\text{ °C}$	-	0.1	0.35	mA

DYNAMIC CHARACTERISTICS

$T_j = 25\text{ °C}$ unless otherwise stated

SYMBOL	PARAMETER	CONDITIONS	MIN.	TYP.	MAX.	UNIT
Q_s	Reverse recovery charge	$I_F = 2\text{ A to } V_R \geq 30\text{ V};$ $di_F/dt = 20\text{ A}/\mu\text{s}$	-	40	60	nC
t_{rr}	Reverse recovery time	$I_F = 1\text{ A to } V_R \geq 30\text{ V};$ $di_F/dt = 100\text{ A}/\mu\text{s}$	-	50	60	ns
I_{rrm}	Peak reverse recovery current	$I_F = 10\text{ A to } V_R \geq 30\text{ V};$ $di_F/dt = 50\text{ A}/\mu\text{s}; T_j = 100\text{ °C}$	-	4.0	5.5	A
V_{fr}	Forward recovery voltage	$I_F = 10\text{ A}; di_F/dt = 10\text{ A}/\mu\text{s}$	-	2.5	-	V

Rectifier diodes
ultrafast

BYV29 series

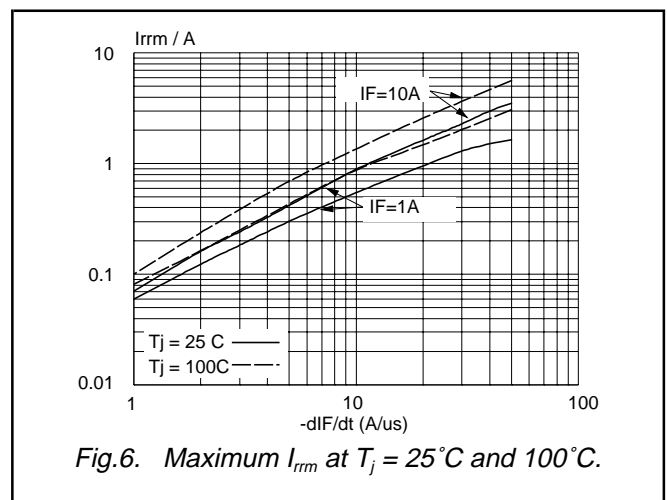
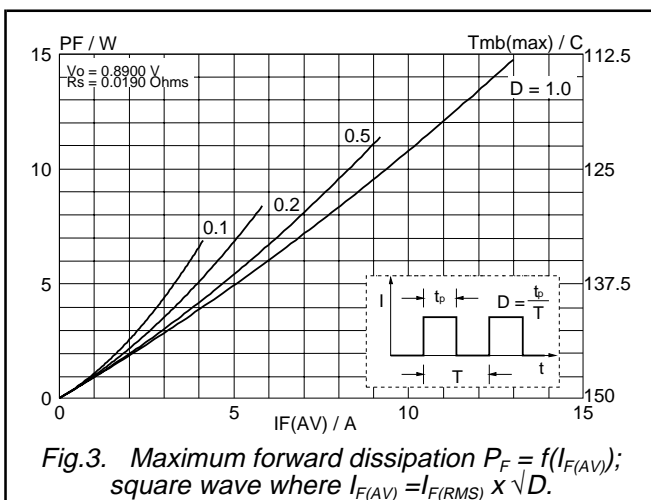
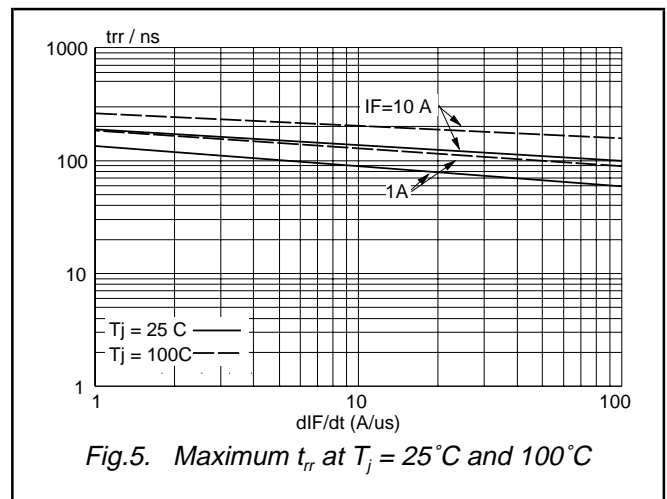
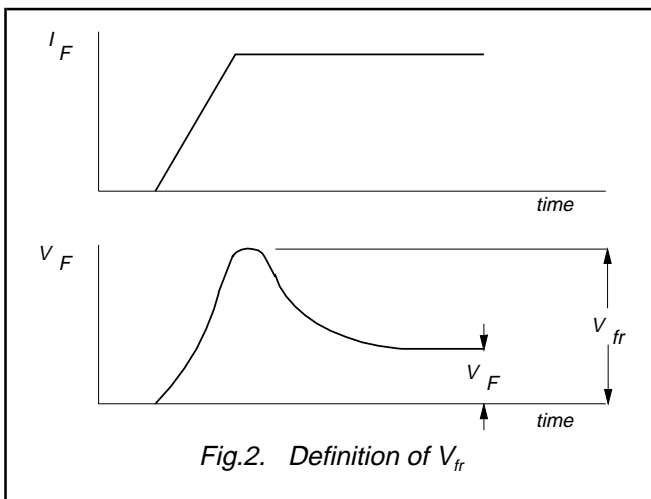
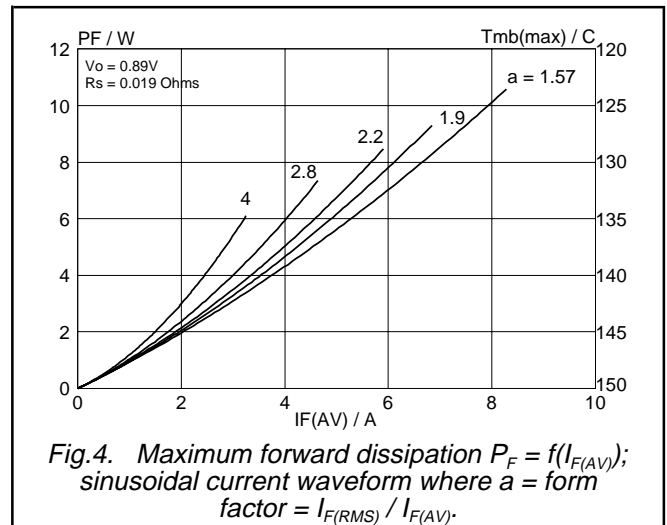
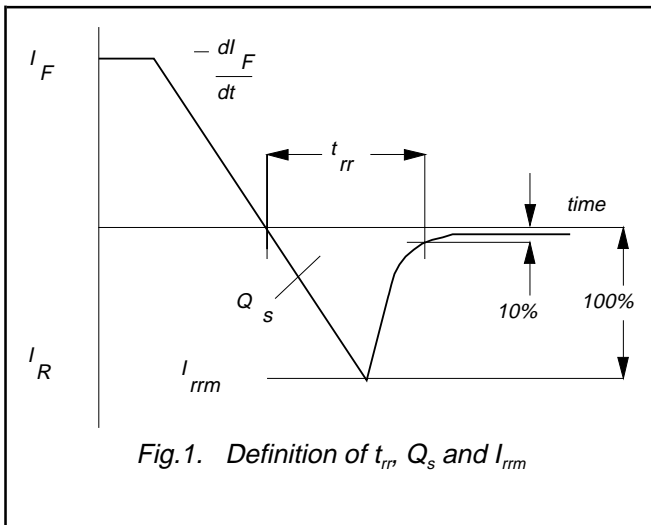

Rectifier diodes
ultrafast

BYV29 series

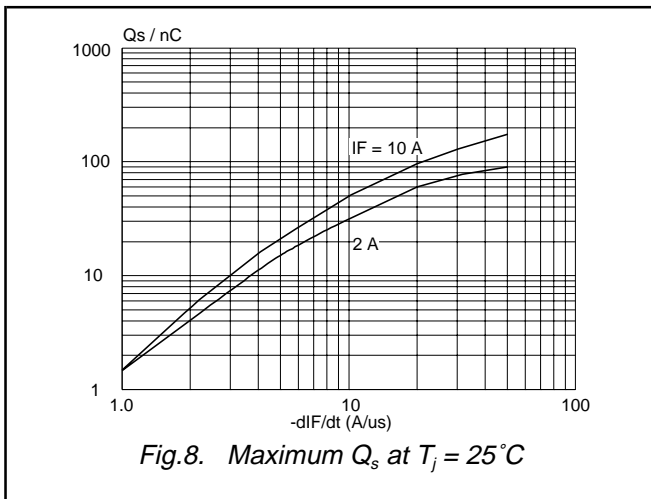
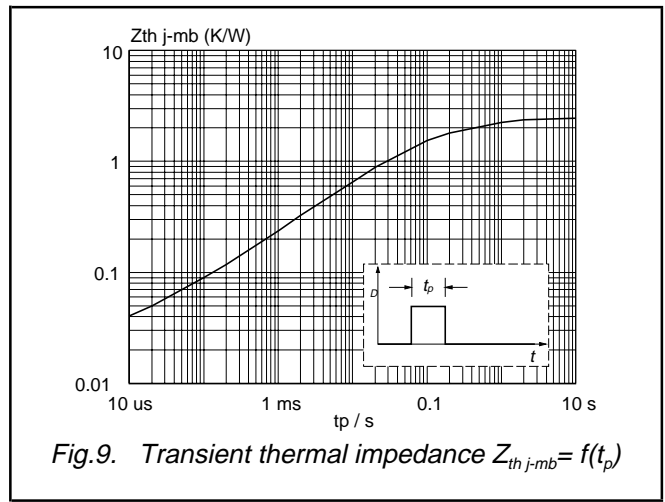
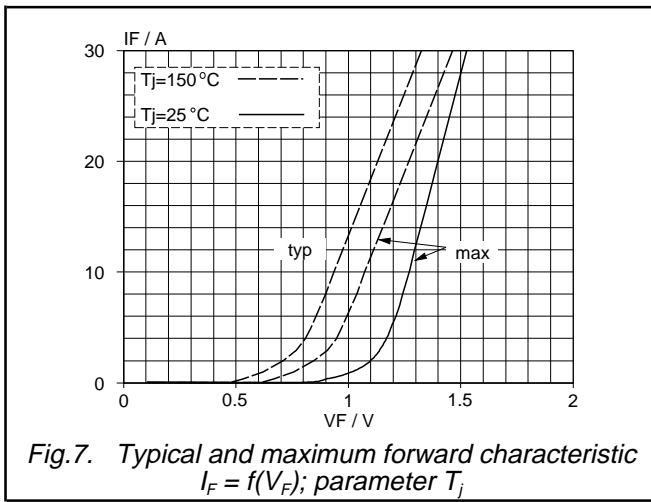

Rectifier diodes
ultrafast

BYV29 series

MECHANICAL DATA

Dimensions in mm

Net Mass: 2 g

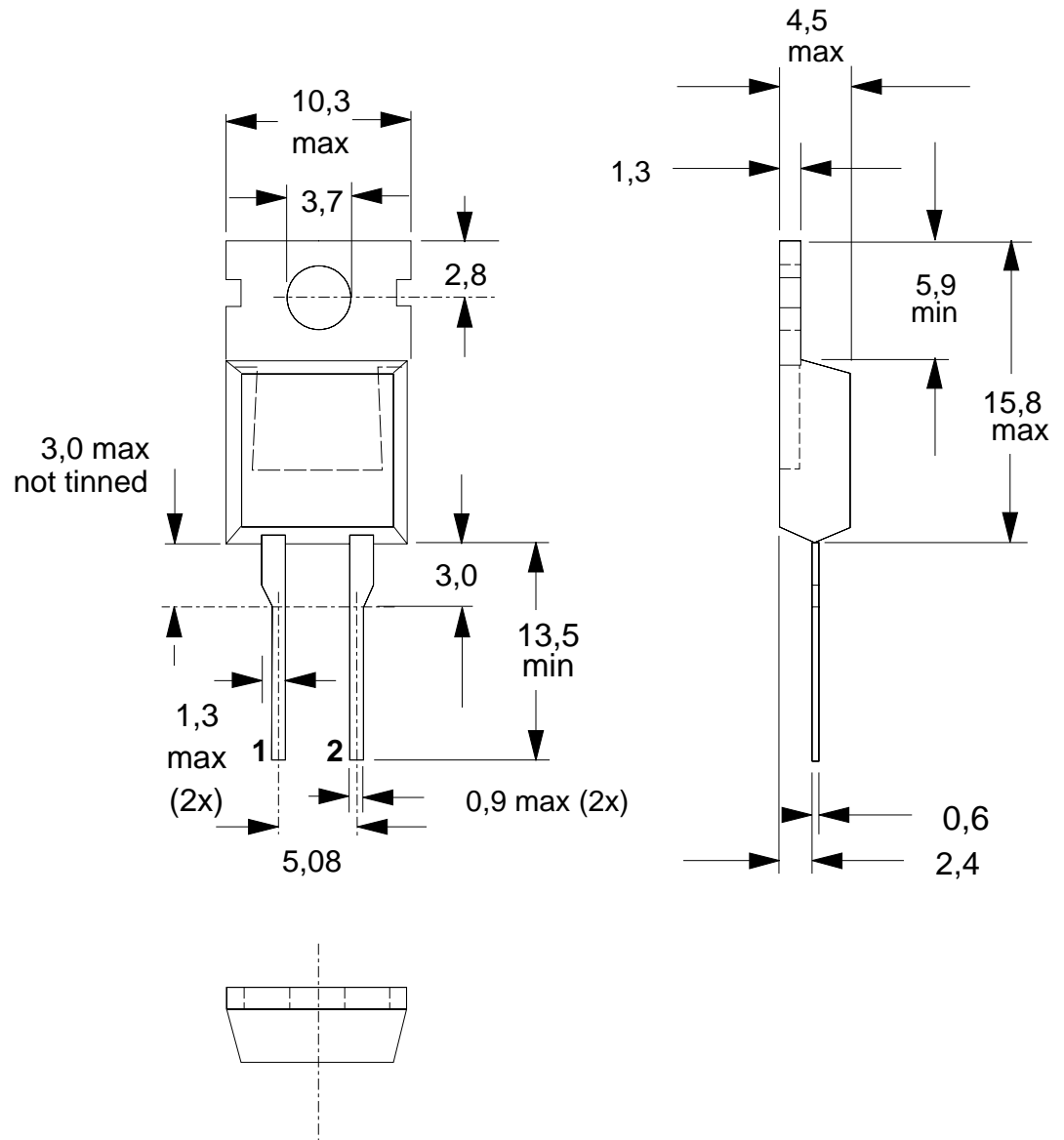

Fig. 10. TO220AC; pin 1 connected to mounting base.

Notes

1. Refer to mounting instructions for TO220 envelopes.
2. Epoxy meets UL94 V0 at 1/8".

**Rectifier diodes
ultrafast**

BYV29 series**DEFINITIONS**

Data sheet status	
Objective specification	This data sheet contains target or goal specifications for product development.
Preliminary specification	This data sheet contains preliminary data; supplementary data may be published later.
Product specification	This data sheet contains final product specifications.
Limiting values	
Limiting values are given in accordance with the Absolute Maximum Rating System (IEC 134). Stress above one or more of the limiting values may cause permanent damage to the device. These are stress ratings only and operation of the device at these or at any other conditions above those given in the Characteristics sections of this specification is not implied. Exposure to limiting values for extended periods may affect device reliability.	
Application information	
Where application information is given, it is advisory and does not form part of the specification.	
© Philips Electronics N.V. 1996	
All rights are reserved. Reproduction in whole or in part is prohibited without the prior written consent of the copyright owner.	
The information presented in this document does not form part of any quotation or contract, it is believed to be accurate and reliable and may be changed without notice. No liability will be accepted by the publisher for any consequence of its use. Publication thereof does not convey nor imply any license under patent or other industrial or intellectual property rights.	

LIFE SUPPORT APPLICATIONS

These products are not designed for use in life support appliances, devices or systems where malfunction of these products can be reasonably expected to result in personal injury. Philips customers using or selling these products for use in such applications do so at their own risk and agree to fully indemnify Philips for any damages resulting from such improper use or sale.