

## Seven Segment Display 13 mm (0.59")

HD 1131  
HD 1133

### Features

- Excellent readability by ambient light
- Excellent character appearance
- Evenly lighted segments
- Wide viewing angle  $2\varphi = 50^\circ$
- Mitred corners on segments
- Grey package provides optimum contrast
- IC-compatible
- Right hand decimal

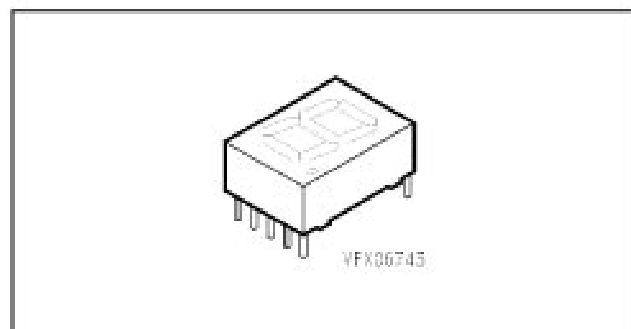

Type	Polarity	Color of emission	Luminous intensity/ Segment $I_F = 10 \text{ mA}$ $I_V (\mu\text{cd})$	Ordering code
HD 1131 R	common anode	red	550 (typ.)	Q68000-A7821
HD 1131 O		super-red	4000 (typ.)	Q68000-A7822
HD 1131 G		green	4500 (typ.)	Q68000-A7820
HD 1133 R	common cathode	red	550 (typ.)	Q68000-A7873
HD 1133 O		super-red	4000 (typ.)	Q68000-A7872
HD 1133 G		green	4500 (typ.)	Q68000-A7871

Maximum Ratings ( $T_A = 25\text{ °C}$ )

Description	Symbol	Value	Unit
Operating temperature range	$T_{op}$	0 ... + 85	°C
Storage temperature range	$T_{stg}$	- 40 ... + 85	°C
Lead soldering temperature, 2 mm from base	$T_S$	260	°C for 3 s
Peak forward current per segment or DP <sup>1)</sup> $t_P \leq 10\ \mu\text{s}$ HD 113* R HD 113* O, -G	$I_{FM}$ $I_{FM}$	500 150	mA mA
DC forward current per segment or DP <sup>2)</sup> HD 113* R HD 113* O, -G	$I_F$ $I_F$	35 25	mA mA
Reverse voltage per segment or DP	$V_R$	6	V
Total power dissipation $T_A \leq 45\text{ °C}$	$P_{tot}$	600	mW

1) Do not exceed maximum average current per segment (see graph of the permissible pulse handling capability)

2) Derate maximum average current above  $T_A = 75\text{ °C}$  at  $0.5\text{ mA/°C}$  per segment

Characteristics ( $T_A = 25\text{ °C}$ )

Parameter	Symbol	Values			Unit
		min	typ.	ma	
Luminous intensity per segment, $I_F = 10\text{ mA}$					
HD 1131 R, HD 1133 R	$I_V$	180	550	-	$\mu\text{cd}$
HD 1131 O, HD 1133 O	$I_V$	110	400	-	$\mu\text{cd}$
HD 1131 G, HD 1133 G	$I_V$	0	0	-	$\mu\text{cd}$
Peak wavelength, $I_F = 10\text{ mA}$					
HD 1131 R, HD 1133 R	$\lambda_{\text{peak}}$	-	660	-	nm
HD 1131 O, HD 1133 O	$\lambda_{\text{peak}}$	-	630	-	nm
HD 1131 G, HD 1133 G	$\lambda_{\text{peak}}$	-	565	-	nm
Dominant wavelength (Digit average)					
HD 1131 R, HD 1133 R	$\lambda_{\text{dom}}$	-	645	-	nm
HD 1131 O, HD 1133 O	$\lambda_{\text{dom}}$	612	-	625	nm
HD 1131 G, HD 1133 G	$\lambda_{\text{dom}}$	562	-	575	nm
Forward voltage per segment*, $I_F = 20\text{ mA}$					
HD 1131 R, HD 1133 R	$V_F$	-	1.6	2.0	V
HD 1131 O, HD 1133 O	$V_F$	-	2.0	3.0	V
HD 1131 G, HD 1133 G	$V_F$	-	2.4	3.0	V
Break down voltage per segment* $I_R = 10\text{ }\mu\text{A}$	$V_{BR}$	6	15	-	V
Max. thermal resistance	$R_{thJA}$	-	-	100	$^{\circ}\text{C/W/Seg}$

\*) AQL = 0.4%

**Relative spectral emission  $I_{rel} = f(\lambda)$**

$V(\lambda)$  = Standard eye response curve

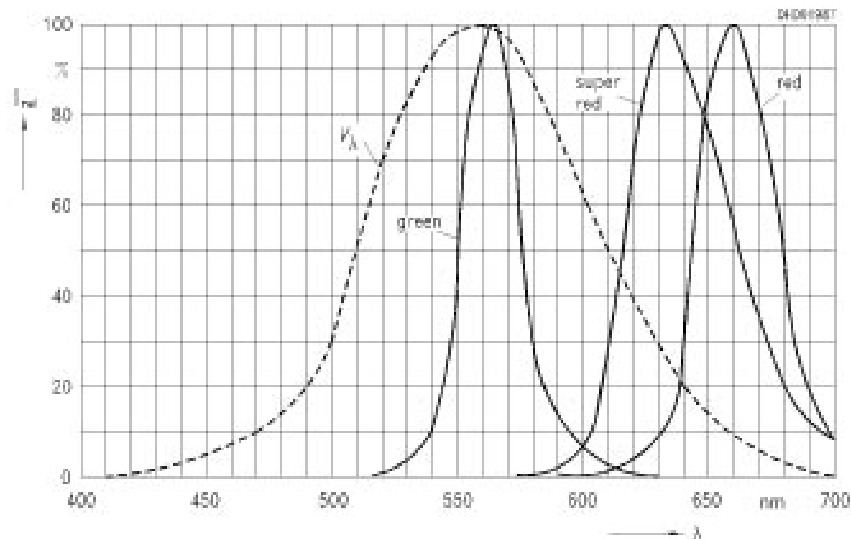

**Forward current  $I_F = f(V_F)$**

$T_A = 25^\circ\text{C}$

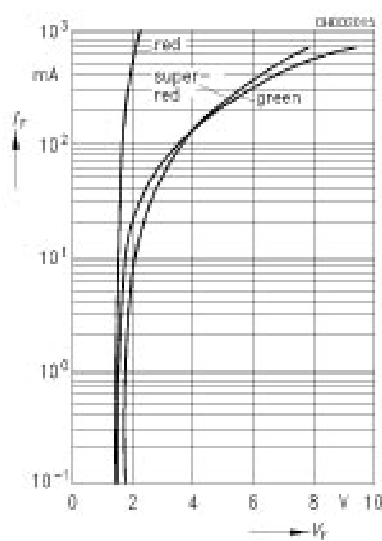

**Rel. luminous intensity  $I_v/I_v(25^\circ\text{C}) = f(T_A)$**

$I_F = 10\text{ mA}$

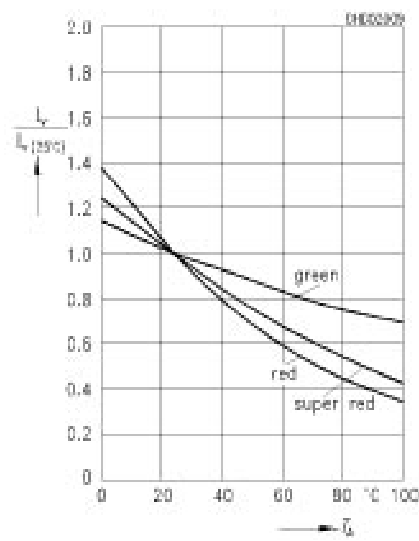

### Permissible pulse handling capability

$$I_F = f(t_p), T_A \leq 45\text{ °C}$$

red

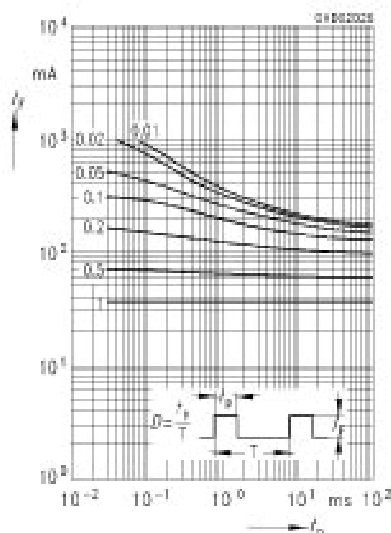

### Permissible pulse handling capability

$$I_F = f(t_p), T_A \leq 45\text{ °C}$$

super-red, green

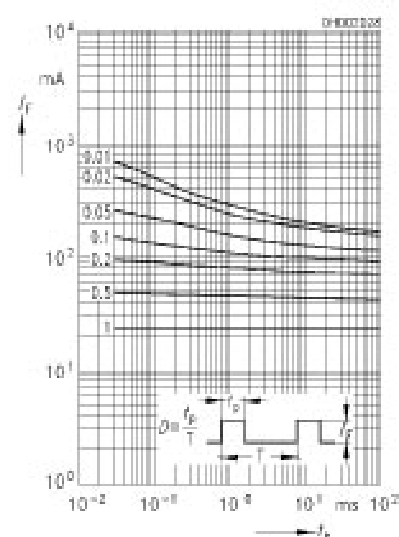

### Max. permissible forward current

$$I_F = f(T_A)$$

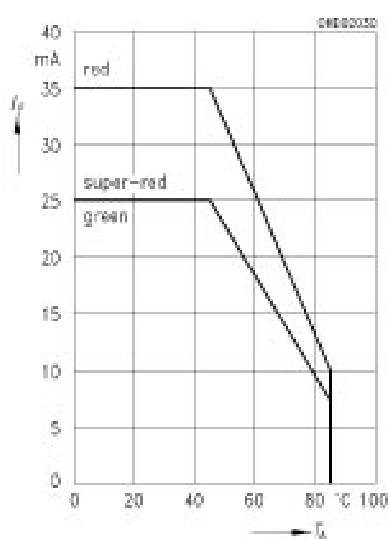

### Rel. luminous intensity $I_v/I_v(10\text{ mA}) = f(I_F)$

$$T_A = 25\text{ °C}$$

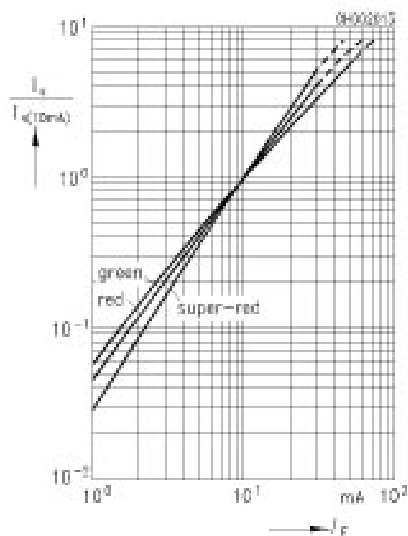

## Total power dissipation $P_{tot} = f(T_A)$

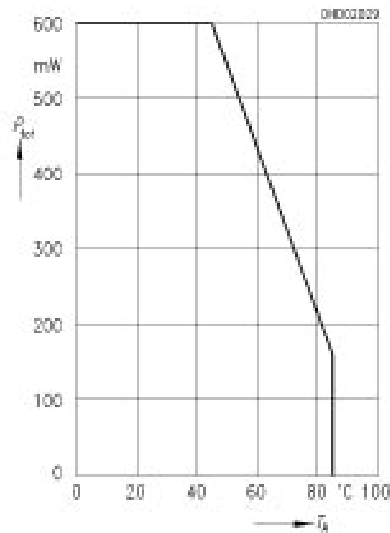

## Package Outlines

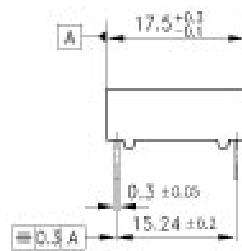
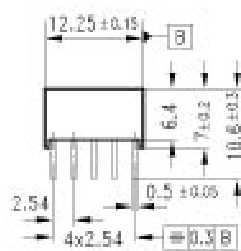

HD 1131  
HDN1131

a-1			10-g
d-2			9-l
A-3			8-A
c-4			7-a
dp-5			6-b

A=common anode

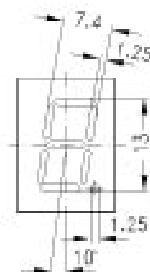

HD 1133  
HDN1133

a-1			10-g
d-2			9-l
C-3			8-C
c-4			7-a
dp-5			6-b

C=common cathode



GP028743