Acorn A5000
Module Level Service Manual

Copyright © Acorn Computers Limited 1991

Published by Acorn Computers Technical Publications Department

Neither the whole nor any part of the information contained in, nor the product described in this manual may be adapted or reproduced in any material form except with the prior written approval of Acorn Computers Limited.

The products described in this manual, and products for use with it are subject to continuous development and improvement. All information of a technical nature and particulars of the products and their use (including the information and particulars in this manual) are given by Acorn Computers Limited in good faith. However, Acorn Computers Limited cannot accept any liability for any loss or damage arising from the use of any information or particulars in this manual, or any incorrect use of the products. All maintenance and service on the products must be carried out by Acorn Computers' authorised dealers or Approved Service Centres. Acorn Computers Limited can accept no liability whatsoever for any loss or damage caused by service, maintenance or repair by unauthorised personnel.

This product is not intended for use as a critical component in life support devices or any system in which failure could be expected to result in personal injury.

If you have any comments on this manual, please complete the form at the back of the manual and send it to the address given there.

ACORN, ARCHIMEDES and ECONET are trademarks of Acorn Computers Limited.
ARM is a trademark of Advanced RISC Machines Limited.

Published by Acorn Computers Limited
ISBN 1 85250 099 9
Part number 0492,059
Issue 1, November 1991

Contents

About this manual	v
Part 1 - Fault diagnosis and repair	1-1
Introduction	1-1
Test equipment required	1-1
Checking a 'dead' computer	1-1
Action if PSU fails	1-3
Action if main PCB fails	1-3
Action if upgrades fail	1-3
What to do next	1-4
Checking a partly working computer	1-4
Before the tests	1-4
Safety considerations	1-4
Backing up the test disc	1-4
Validating the test equipment	1-4
Creating a test IDE hard disc	1-6
Replacing the customer's hard disc	1-6
Connecting the customer's equipment	1-6
Saving the customer's CMOS RAM settings	1-7
Creating a CMOS test data file	1-7
Checking the memory size	1-7
About the tests	1-8
How to operate the test software	1-8
Repairing faults	1-8
Running the functional tests	1-8
Memory test	1-9
Battery backed RAM test	1-9
IDE hard disc drive interface test	1-9
Hardware check	1-10
External port tests	1-10
Disc interface test	1-11
Real time test	1-12
Audio tests	1-12
Video tests	1-12
Keyboard and mouse tests	1-14
Test report	1-16
Additional individual tests	1-16
Hard disc exerciser	1-16
Hard disc formatter	1-16
After the tests	1-17
Performing soak tests	1-17
Performing safety tests	1-17
Retesting the unit	1-17
Restoring the CMOS RAM settings	1-19

Replacing the customer's hard disc	1-19
Switching off the equipment	1-19
Disconnecting the equipment	1-19
Packing	1-19
Part 2 - Disassembly and assembly	2-1
Introduction	2-1
Removing the top cover	2-1
Removing the backplane	2-2
Removing cables	2-2
Removing the main PCB	2-2
Removing the disc drives	2-2
Removing the speaker	2-3
Removing the front plastic moulding	2-3
Removing the power supply unit	2-3
Main unit assembly	2-4
Power supply unit	2-4
Speaker	2-4
Disc drives	2-4
PCB	2-4
Keyboard	2-4
Disassembly	2-4
Assembly	2-4
Mouse	2-4
Appendix A - Mouse jig template	A-1
Appendix B - Serial port loopback plug	B-1
Appendix C - Earth continuity testing	C-1
Appendix D - DC insulation testing - class 1	D-1
Appendix E - Monitor adaptor cables	E-1
Appendix F - Main PCB links, plugs & sockets	F-1
Appendix G - Final assembly parts list	G-1
Drawings	
Final assembly drawing	

About this manual

This manual is a module level service manual for the Acorn A5000 computer. It is intended as a guide for suppliers at Acorn Service Centres to enable them to trace and repair faults at a module level. Suppliers are not expected to undertake repairs at a component level, as surface mount technology is used on the printed circuit boards of the A5000 computer. Any modules which require component level repairs should be sent to an Acorn Authorised Central Service Workshop.

This manual supplements the basic information given on system hardware in the *Welcome Guide* and *Technical Reference Manual* (available for separate purchase).

The operating system is covered at the user level in the *RISC OS User Guide*, supplied with certain models (also available for separate purchase). Programmers and users requiring a greater depth of information about RISC OS will also need the following manual:

RISC OS Programmer's Reference Manual
(a boxed set)

This manual is available from Acorn authorised suppliers. Full details on the Acorn ARM chip set used in the workstation are given in the *Acorn RISC Machine (ARM) Family Data Manual*, ISBN 0-13-781618-9, available from:

VLSI Technology, Inc.
Application Specific Logic Products Division
8375 South River Parkway
Tempe, AZ 85284
USA
602-752-8574

or from the VLSI national distributor.

Part 1- Fault diagnosis and repair

Introduction

This chapter is a guide to the diagnosis and repair at a modular level of basic faults in the Archimedes 5000 series computer system.

It consists of algorithms to enable you to trace and remedy faults in a 'dead' computer, followed by instructions for running the Archimedes functional test software, which is designed to isolate faults in a computer which is partly working.

Note: Throughout this chapter the acronym UUT is used to mean Unit Under Test and the acronym CSW to mean Central Service Workshop.

SAFETY CONSIDERATIONS

WHENEVER ANY SERVICE OR UPGRADE IS PERFORMED, ENSURE THAT ALL THE FUNCTIONAL TESTS AND SAFETY TESTS AS DESCRIBED IN THIS SECTION ARE CARRIED OUT.

FULL FUNCTIONAL AND SAFETY TESTS SHOULD BE APPLIED IRRESPECTIVE OF THE ORIGINAL FAULT OR WORK PERFORMED.

FAILURE TO CARRY OUT THE TESTS IN FULL MAY RESULT IN AN UNSTABLE OR UNRELIABLE UNIT BEING RETURNED TO THE CUSTOMER.

DANGER

BEFORE ATTEMPTING TO OPEN THE COMPUTER OR EXCHANGE EITHER THE PSU (POWER SUPPLY UNIT) OR PCB, ENSURE THAT YOU HAVE READ AND FULLY UNDERSTOOD ALL THE INSTRUCTIONS IN *Part 2 - Disassembly and assembly*. IN PARTICULAR, ENSURE THAT YOU DISCONNECT THE COMPUTER, MONITOR AND PERIPHERALS FROM THE POWER SUPPLY.

UNDER NO CIRCUMSTANCES SHOULD ANY ATTEMPT BE MADE TO REPAIR OR MODIFY THE PSU. ANY ATTEMPT TO DO SO WILL INVALIDATE THE ORIGINAL SAFETY TESTS APPLIED AT MANUFACTURE AND MAY CREATE A SAFETY HAZARD.

WHEN REFITTING OR FITTING A REPLACEMENT ASSEMBLY, CHECKS SHOULD BE MADE FOR EARTH CONTINUITY BETWEEN THE EARTH PIN OF THE MAINS PLUG AND THE FOLLOWING:

- THE BASE METALWORK
- THE REAR PANELS (INCLUDING BLANKING PANELS AND CONNECTING PLATE)
- THE TOP COVER

USE AN EARTH CONTINUITY TESTER SET TO 25 AMPS. FOR DETAILS REFER TO *Appendix C - Earth continuity testing* AND *Appendix D - DC insulation testing - class 1*.

Test equipment required

- DC Voltmeter
- A5000 test disc (Acorn part number 0292,824)
- a blank 1.6 MB ADFS F format write-enabled, 3.5 inch floppy disc (used as a scratch disc in the disc interface test)
- test IDE hard disc (see the section entitled *Creating a test IDE hard disc* on page 1-6)
- serial port loopback plug – see *Appendix B - Serial port loopback plug*
- parallel to video loopback box (0092,800)
- headphones (32 ohm impedance)
- analogue multisync colour monitor (suitable for super VGA)
- Epson FX80 compatible printer (Olivetti JP101 or Epson FX80)
- 2 x blank 800K ADFS E format write-enabled, 3.5 inch floppy discs:
 - *data disc* – to store the customer's CMOS RAM configuration data
 - *CMOS RAM test data disc* – to store the manufacturer's default CMOS RAM settings (see the section entitled *Creating a CMOS test data file* on page 1-7)
- working keyboard (0392,900) and mouse (0183,180)
- mouse test jig template (see *Appendix A - Mouse test jig template*)
- working backplane (0192,004)
- standard hand tools, such as screwdrivers and pliers
- earth testers (see *Appendix C - Earth continuity testing*)
- isolation tester (see *Appendix D - DC insulation testing - class 1*).

Checking a 'dead' computer

This section describes the initial tests that you should perform on an apparently 'dead' computer to discover which module or upgrade is faulty. If the computer is partially working (i.e. any faults occur after a successful power-up) go straight to the section entitled *Checking a partly working computer* on page 1-4.

To diagnose the faults in a 'dead' computer, refer to the procedure given in the flowchart, *Figure 1-1: Procedure to check a 'dead' computer* on page 1-2. The sections following describe the actions to be taken when you have isolated the fault on the computer.

Note: You may need to reconfigure the CMOS RAM to its original (factory) default setting. Make sure that the customer is made aware of this.

Figure 1-1: Procedure to check a 'dead' computer

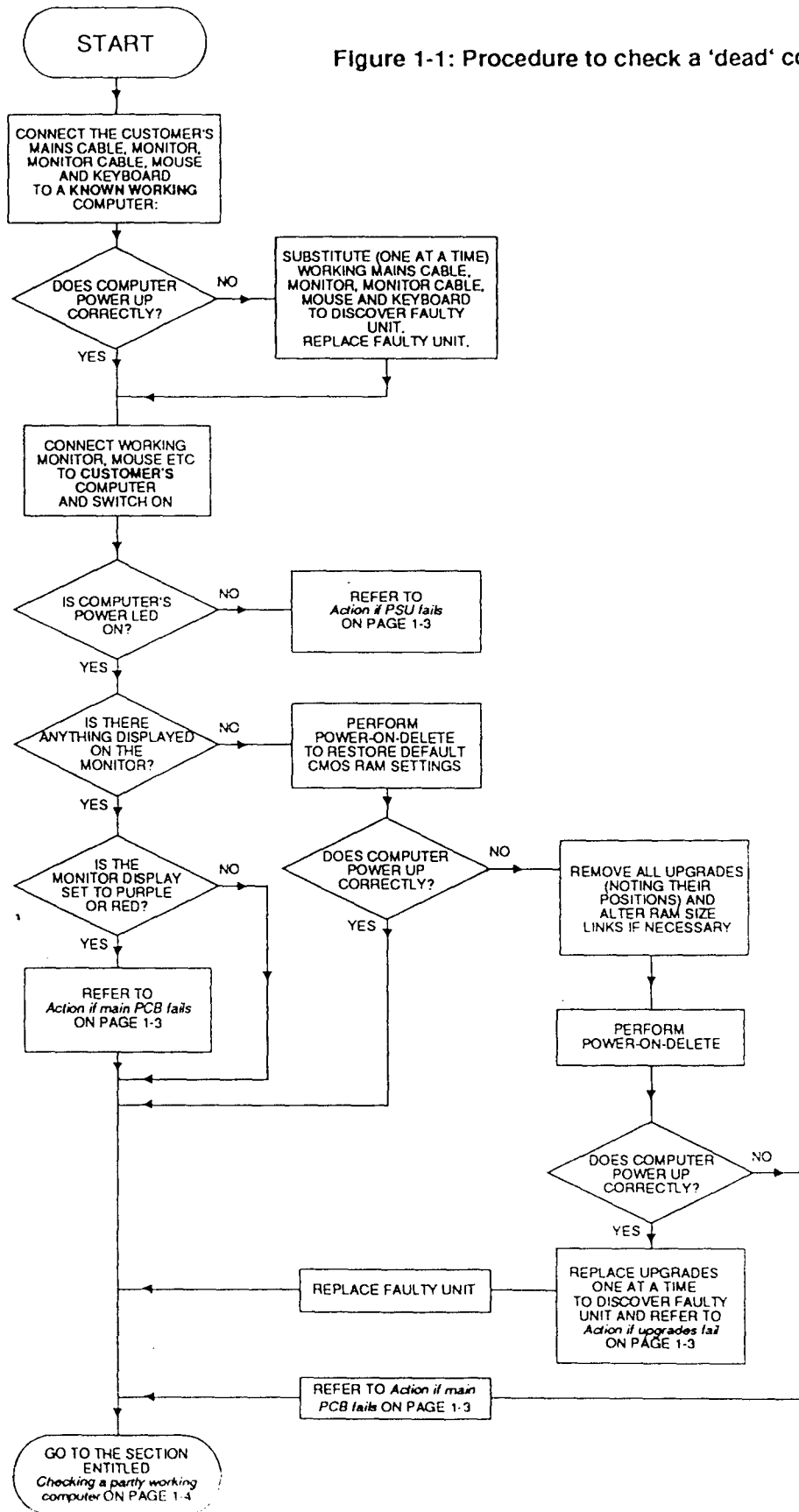

Action if PSU fails

There are three ways in which the power supply unit (PSU) may fail:

- complete failure
- individual rail failure
- thermal shutdown

The **complete failure** of the PSU is indicated by the following symptoms:

- no cooling fan noise
- no green LED on the front panel
- no caps lock LED response when caps lock key depressed

First check that the fuse in the mains plug has not blown. To do this, remove the fuse from the plug and check with a continuity tester. If it has blown then replace only **with a fuse of the same rating** (for UK machines this will be 5 Amp). If the new fuse is blown when you switch the unit on, then return the PSU to an Acorn Authorised Central Service Workshop (CSW).

If there is an **individual rail failure** within the PSU, various functions of the computer will fail as follows:

- 5V feeds the main PCB, floppy disc and hard disc.
- -5V feeds the backplane expansion connector on pin A31.
- +12V feeds the video connector (SK1) on pin 12 (when driving a SCART TV) and the backplane expansion socket on pins B31 and B32.

Ensure that the PSU faston power connectors are securely attached to the main PCB and that the flying connectors are firmly attached to the drives. If this does not correct the fault, return the PSU to an Acorn Authorised CSW for repair.

If the PSU functions for a while before failing, it is likely that a controlled **thermal shutdown** has taken place. This is caused by either a failure of the cooling fan or a failure of a component that is internal to the PSU.

Switch on and listen for the fan and check that the fan aperture is not congested or blocked with any debris. Should the fan fail to run or the PSU continue to shut down then return the PSU to an Acorn Authorised CSW for repair.

Action if main PCB fails

Although the main PCB is a replacement only item, there are some checks that you can make before sending a faulty PCB to an Acorn Authorised CSW.

Remove the PCB from the main unit, using the procedure given in *Part 2 - Disassembly and assembly* and inspect the board for any of the following:

- ROMs not in correct sockets or pins lifted from sockets.
- ROM size and type links incorrectly set. See *Appendix F - Main PCB links, plugs & sockets* for links LK10, LK11, LK12 and LK14.

- Incorrect location and orientation of any other socketed devices.
- DRAM size links incorrectly set. See *Appendix F - Main PCB links, plugs & sockets* for links LK23 and LK24.

- Any loose debris lying on the PCB.

If these checks do not disclose the fault, return the PCB to an Acorn Authorised CSW for repair.

Action if upgrades fail

RAM Card

To check the RAM card, disassemble the computer as described in *Part 2 - Disassembly and assembly* and check the following:

- The RAM card plug is securely placed in the main PCB socket.
- The links on the main PCB are set correctly - see *Appendix F - Main PCB links, plugs & sockets* for LK23 and LK24.
- The ZIP ICs are correctly installed in their sockets on the expansion card.
- The combined amount of DRAM on the RAM card and the memory size of the main computer is correct:
 - 2MB on the main PCB and 1MB or 3MB on the RAM card is illegal
 - 1MB on the main PCB and 2MB on the RAM card is illegal
 - 4MB on the main PCB and any RAM card is illegal

If these checks do not isolate the fault, substitute the RAM card for a known working RAM card (checking LK23 and LK24 as you do). Depending on the outcome of this test, send either the RAM card or the main PCB to an Acorn Authorised CSW for repair.

Backplane

To test the backplane, you need to run a number of expansion cards from it. (See the documentation supplied with the individual Acorn expansion cards for details). Once you have seen a fault occur on more than one expansion card, disassemble the unit and remove the backplane as described in *Part 2 - Disassembly and assembly*. Check that none of the pins in the plug housing are damaged or bent. Also inspect the expansion card sockets for damage or blockage.

If you can detect the fault, refit the backplane making sure that it is installed securely into the main PCB socket. Retest the backplane using a known working expansion card.

If you cannot isolate the fault, substitute a known working backplane for the existing backplane and retest. Depending on the result of this test, return either the backplane or the main PCB to an Acorn Authorised CSW.

What to do next

Once you have repaired a fault and the computer is functioning, we recommend that you use the test software described in the following section entitled *Checking a partly working computer*, to check for and correct any other faults.

Checking a partly working computer

The following section gives details of how to isolate faults to individual modules, using the test disc (0292,824) on machines which are running, but exhibiting faults. The test software can be used in two ways:

- As a test suite, including all the tests that you need for a standard configuration machine. The tests run automatically and in sequence.
- As individual tests to test an individual module.

We suggest that if the description of a fault is specific to a module then you only need to run the appropriate individual test. Once you have determined the area of the fault and repaired it, make sure that you run the full test suite on the working computer before returning it to the customer.

The flowchart on the next page, *Figure 1-2: Procedure to check a partly working computer* shows you how to diagnose and repair a partly working computer.

Before the tests

Before you run the test software suite, you need to perform the following tasks:

- back up the test disc
- validate the test equipment
- create a test IDE hard disc
- replace the customer's hard disc
- connect the customer's equipment
- save the customer's CMOS RAM settings
- create a CMOS test data file
- check the memory size of the computer

Safety considerations

Some of the tasks described in this section require that you remove the top cover of the Archimedes computer. Although the PSU is designed to comply with BS7002/EN60950 Class 1, you must still take care to ensure that no metal objects fall (or are put) into the PSU through the ventilation holes.

Notes:

- 1 You must only connect the power **after** you have made all the other connections.
- 2 You must switch off the equipment and disconnect from the mains supply **before** removing any other connections.

You will find instructions for removing the top cover in *Part 2 - Disassembly and assembly*.

Backing up the test disc

Before you start testing, make a backup copy of the test disc (0292,824). You will need the following equipment:

- a known working A5000 computer plus keyboard and monitor.
- test disc to be copied (*source disc*).
- floppy disc already formatted (*destination disc*).

Follow the procedure given below to make a backup copy of the test disc:

- 1 Start-up the computer so that it displays the desktop. Note if the desktop is not displayed on start-up type:

```
*DESKTOP <return>
```

 at the * prompt.
- 2 Ensure the test floppy disc is write protected, then insert the test floppy disc into the disc drive.
- 3 Open the directory window on the floppy disc by pressing the left hand mouse key while the mouse pointer is over the floppy disc icon.
- 4 Execute the !MakeACopy program by pressing the left hand mouse key twice while the mouse pointer is over the !MakeACopy icon in the directory window.
- 5 You are asked whether you are sure that you want to back up the test disc. Reply 'y' if the test disc is write protected.
- 6 Press the space bar when prompted.
- 7 Insert the destination disc when prompted.
- 8 When the program has finished, turn off the monitor and computer.

Validating the test equipment

Before carrying out any of the tests in this chapter, validate the test equipment. To do this, follow the procedures given in this section, substituting a known working unit for the customer's unit.

If the test equipment fails, you should repair the test equipment and retest on a known working unit.

Figure 1-2: Procedure to check a partly working computer

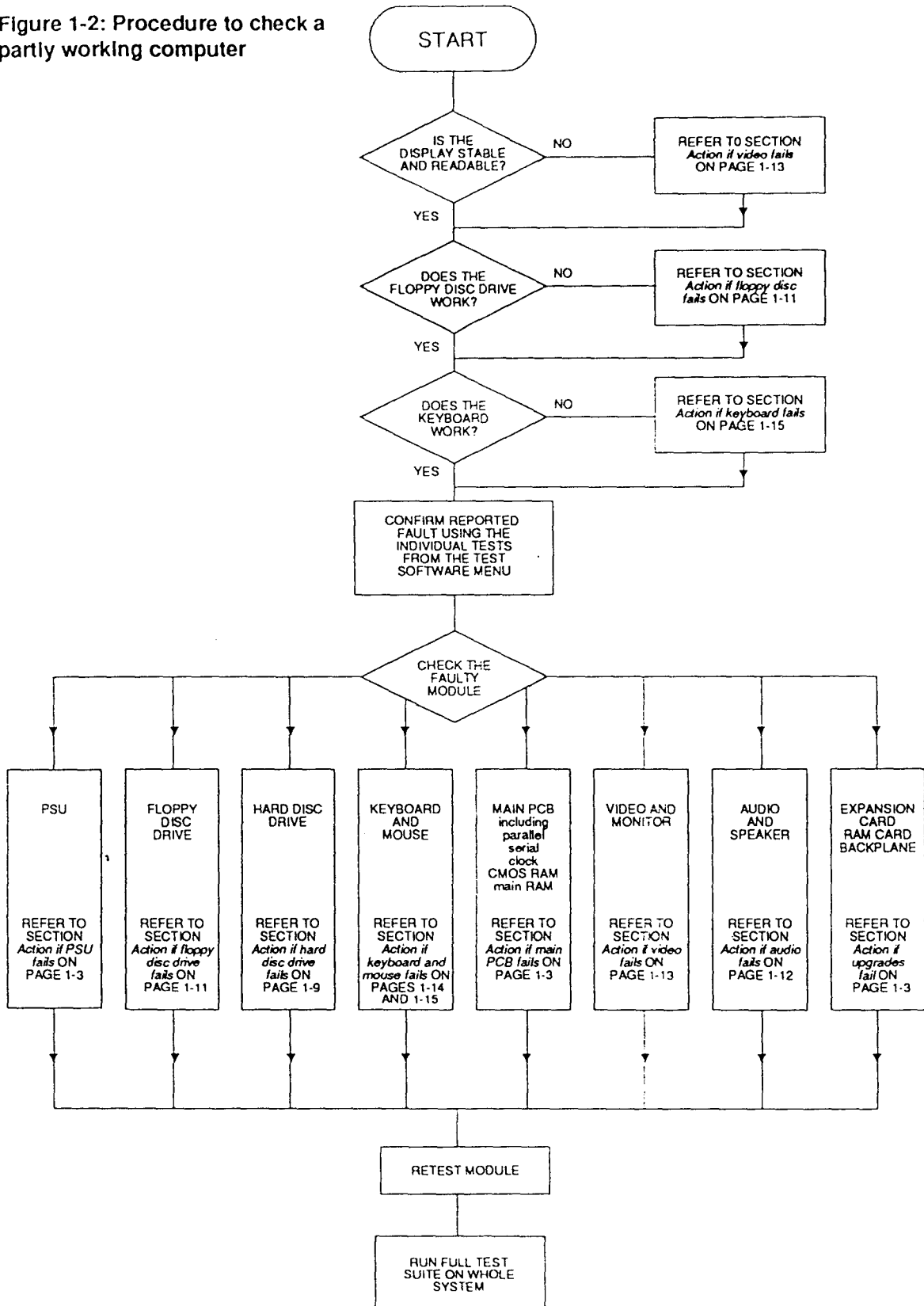

Creating a test IDE hard disc

To avoid overwriting the customer's hard disc during testing, prepare a test hard disc. You will need the following equipment:

- IDE hard disc to be initialised (UUT)
- A5000 test disc (Acorn part number 0292,824)
- A5000 series test station, which is made up of an A5000 series computer with the hard disc removed and a keyboard attached (do not use a customer's computer for this test)
- Standard RGB colour monitor (Analogue RGB) and cable.

Notes:

- 1 Throughout the test procedure make sure that the power is the last connection made before a test commences, and the first connection removed when a test is complete.
- 2 The mains supply voltage must be within the rated voltage range as indicated on the PSU input label.
- 3 If a message is expected and has not appeared within 30 seconds then record the fault and repair the machine. If an error message appears, record the fault and, if possible, continue the test and then repair the machine.
- 4 If the test equipment fails three consecutive UUT's for the same fault, validate the equipment using a known good UUT and repair as necessary before continuing with the test.

The procedure to test an IDE hard disc is given below.

- 1 Insert the UUT into the test station, taking care to plug the two cables in correctly. Replace the A5000's top cover.
- 2 Connect the test station and the monitor to the mains supply. Do **not** turn on.
- 3 Insert the test disc into the floppy disc drive.
- 4 Turn on the monitor.
- 5 Turn on the test station whilst holding down the Delete key, Shift key and * key (until the auto-boot file is executed). Use the * key on the numeric keypad *not* the * key on shift 8.
- 6 The following menu is displayed:

```
MENU VX.XX UN-DEF
```

- ```
(A) Test Suite
(B) Individual Tests
(C) Load / Save CMOS
(D) Quit
```

Select the test type of your choice

Select the Individual Test option by typing B.

- 7 The following menu appears on the screen:

```
Individual Tests
```

- ```
(A) Exp-Cards
(B) Pcb-Module
```

Select the Pcb-Module option B.

- 8 From the list that follows, select the option `Format IDE drive 4` by pressing 0. A configuration screen will then appear which will be followed by the formatter screen. The disc is then formatted. For details of the hard disc formatter program, refer to the information given in the section entitled *Hard disc formatter* on page 1-16.
- 9 When formatting, and initialising is complete, you will be asked to press the space bar to continue. This produces the report screen that displays the pass/fail message.
- 10 Press the space bar and, when requested, turn off the test station.
- 11 Turn all the mains supplies to the equipment off.
- 12 Disconnect the UUT, from all associated equipment, in reverse order to that detailed earlier in this procedure.

If any fail messages have occurred, the UUT must be sent for repair and retested.

The hard disc is now ready to be inserted in the customer's computer to test the computer system.

Replacing the customer's hard disc

WARNING:

IT IS NECESSARY TO REPLACE THE CUSTOMER'S HARD DISC BEFORE RUNNING THE TEST SUITE, AS RUNNING THE HARD DISC TESTS MAY DESTROY THE DATA HELD ON THE DISC.

To ensure that the customer's hard disc is not overwritten during the test, disconnect the fitted hard disc and place it in a safe place. Connect and secure the test IDE hard disc into the computer (see the above section entitled *Creating a test IDE hard disc*).

Connecting the customer's equipment

Connect the customer's equipment in the following order:

- 1 keyboard to front panel connector
- 2 serial port loopback plug to the RS232 port
- 3 printer to the video loopback box printer connector
- 4 headphones to the Headphones 32 Ohm socket
- 5 parallel to video loopback box between the parallel port and video socket
- 6 multi-sync analogue RGB monitor to the parallel to video loopback box video socket
- 7 monitor to the mains supply (do not switch on yet)
- 8 computer to the mains supply (do not switch on yet).

Saving the customer's CMOS RAM settings

You need to save the contents of the CMOS RAM before any of the tests are run, and restore them when the last test is over, otherwise the settings will be overwritten.

This is because the test software uses the CMOS RAM to control the test sequence and store the results.

Follow the procedure given below to save the customer's CMOS RAM settings.

- 1 Insert the test disc (0292,824) into the floppy disc drive.
- 2 Hold down the Shift key and switch the computer on (do not touch the Delete key). Keep the Shift key held down while the computer powers up.

The following menu will be displayed:

```
MENU VX.XX UN-DEF
```

```
(A) Test Suite
(B) Individual Tests
(C) Load / Save CMOS
(D) Quit
```

Select the test type of your choice

- 3 Select option (C) Load / Save CMOS by pressing the C key.
- 4 The Load / Save CMOS selection will be confirmed and then the screen will display the following menu:

```
LOAD / SAVE CMOS RAM VX.XX UN-DEF
```

```
1. Save CMOS RAM to disc.
2. Load CMOS RAM from disc.
3. Exit Program.
```

Please select the required option ?

- 5 Select option 1, and then replace the test floppy disc with the data disc.
- 6 When prompted, enter the filename (including the full directory path if necessary) that you want the CMOS RAM saved to.
- 7 Remove the data disc and put it in a safe place.
- 8 Press the space bar to continue.
- 9 Type 3 to exit the program.
- 10 Switch off the computer (leave the monitor on).

Creating a CMOS test data file

If you intend to run the full test suite or the CMOS RAM test (see the section entitled *Battery backed RAM test* on page 1-9) you need to create a CMOS test data file to save the manufacturer's default settings. Note that before you do this you must save the customer's CMOS RAM settings as described in the previous section.

To create a CMOS test data file, proceed as follows:

- 1 Switch off the computer (leave the monitor on).
- 2 Insert the test disc (0292,824) into the floppy disc drive of the customer's computer.

- 3 Switch on the computer, whilst holding down the Delete key (not the backspace key), the Shift key and the * key on the numeric keypad. Keep holding down these keys for several seconds, until the auto-boot file is executed. (This action clears the CMOS RAM and resets the configuration defaults to the manufacturer's original specification).

- 4 A boot file now runs and displays the following menu:

```
MENU VX.XX UN-DEF
```

```
(A) Test Suite
(B) Individual Tests
(C) Load / Save CMOS
(D) Quit
```

Select the test type of your choice

- 5 Select the Load / Save CMOS option from the menu.
 - 6 Select the Save CMOS to disc option.
 - 7 When prompted, enter the path and file name where you want the default CMOS RAM settings saved.
 - 8 Store this test data file on a separate disc (the CMOS RAM test data disc).
 - 9 Remove the test data disc and put it in a safe place.
 - 10 Press the space bar to continue.
 - 11 Type 3 to exit the program.
 - 12 Switch off the computer (leave the monitor on).
- You have now created a new CMOS RAM test data file.

Checking the memory size

You should check the amount of memory that is fitted to the computer and make a note of the size as you will be asked to choose the computer configuration in the test suite. Each computer will have either 1 or 2 MB on the main PCB and either 1, 2, or 3 on the memory expansion card if any are fitted.

To find out the memory size of the computer either ask the customer or remove the top cover as described in *Part 2 - Disassembly and assembly* and check how much memory there is in the machine.

About the tests

The test disc (0292,824) contains various menu-driven tests. The menus are generated from a set of text files. (You can generate new text files if you wish).

There are two types of test:

- subjective – you must judge whether the equipment passes or fails these tests. For this reason it is a good idea for you to familiarise yourself with the correct results given by a known good computer (see the section entitled *Validating the test equipment* on page 1-4). In this way you will be in a better position to judge faulty results.
- non-subjective – the test program passes or fails the equipment.

How to operate the test software

The tests are menu-driven, so the menu option that you select determines the test to be executed. To select an option, type the corresponding letter. Some menu options lead to further options, other options run tests immediately.

During the test sequence, the software runs through each individual test and then prompts you to press the space bar:

```
PRESS <SPACE BAR> TO CONTINUE
```

If the computer passes the current test, the test program waits for approximately 1 second and, if you do not press the space bar in this time, continues with the next test. If you do press the space bar within the 1 second period, the program continues immediately.

If the computer fails the current test, the test program beeps and waits for you to press the space bar. This allows you to make a note of the fault and then continue with the tests. You should also note any other failures, but bear in mind the possibility that these failures could be caused by the first recorded failure.

If an expected message has not appeared on the screen within 30 seconds, you must record the fault, switch off the machine and repair before retesting.

Repairing faults

When repairing a computer, you should repair the faults in the order in which they occurred during the test (i.e. repair the first recorded failure first).

Running the functional tests

The following is an example of how to test a standard computer.

Note: In order to run the functional tests you must first have saved the customer's and manufacturer's CMOS RAM settings, as described in the previous sections.

- 1 Insert the test disc (0292,824) into the floppy disc drive.
- 2 Switch on the computer, whilst holding down the Delete key (not the backspace key), the Shift key and the * key on the numeric keypad. Keep holding down these keys for several seconds, until the auto-boot file is executed. (This action clears the CMOS RAM and resets the configuration defaults to the manufacturer's original specification).
- 3 A boot file now runs and displays the following menu:

```
MENU VX.XX UN-DEF
```

- (A) Test Suite
- (B) Individual Tests
- (C) Load / Save CMOS
- (D) Quit

Select the test type of your choice

- 4 To run the entire test suite, select option A from the above menu. To run an individual test, select option B from the menu and select the appropriate test. Refer to the section entitled *Additional individual tests* on page 1-16 for details of the individual test menus and then read the description of the test in the following sections. The instructions below refer to the full functional test suite.
- 5 If you selected option A, select the A5000 option from the next menu which will configure the CMOS RAM for the selected computer. The computer displays a list of choices:
 - (A) A5000 1Mb Fun. Test
 - (B) A5000 1Mb Soak Test
 - (C) A5000 2Mb + HD Fun. Test
 - (D) A5000 2Mb + HD Soak Test

Press * to quit - for top menu

Select the functional test that is correct for the memory configuration of the machine.
- 6 A list of settings will then appear on the screen. These are the test configuration modules read from the test data file and set up in the CMOS.

Memory test

The screen will clear and the following menu is displayed:

```

      MEMORY TEST VX.XX DEALER

Amount of Memory 2 Mbytes

Running four phase memory test.

Lower memory limit &000088BC
Upper memory limit &00141EA0

Phase one : incrementing pattern....
Phase two : Cycling bits.....
.....
Phase three : TRUE Hierarchy.....
.....
Phase four : FALSE Hierarchy.....
.....
PASSED.....

      PRESS <SPACE BAR> to continue

```

You should check that the amount of memory displayed is the same as that you made a note of at the end of the section entitled *Checking the memory size* on page 1-7.

Note: The upper and lower memory limit can vary slightly between releases of the test software, hence approximate values are given.

Action if the memory test fails

If the test fails, refer to the sections entitled *Action if main PCB fails* and *Action if upgrades fail* on page 1-3.

Battery backed RAM test

The test continues by testing the battery backed RAM. The following is displayed on the screen:

```

      CMOS TEST VX.XX DEALER

Copied CMOS RAM into main memory.
Passed CMOS RAM Configuration.
Passed Read - Write function.
Copied CMOS RAM from main memory.
Passed CMOS RAM Verification Test

      THIS SUB TEST HAS PASSED

      PRESS <SPACE BAR> TO CONTINUE

```

During the Read - Write function test of the CMOS RAM you will be requested to enter the file name for the CMOS data file that should be used for this test. This file contains some of the CMOS data, and will change with different configurations of unit (i.e. IDE fitted etc). You should press Return to use the default data file. If you need to use a specific file, not the default, then enter the path and filename of the data file to be used (this is the one you created in the section entitled *Creating a CMOS test data file* on page 1-7).

Action if the battery backed RAM test fails

Check that the CMOS test data file is correct (see the section entitled *Creating a CMOS test data file* on page 1-7). If the test still fails, then refer to the section entitled *Action if main PCB fails* on page 1-3.

Note: If this test fails you cannot rely on the results of the remaining tests. This is because the CMOS RAM is used to control the test sequence and store the results.

IDE hard disc drive interface test

The screen will clear and the following will be displayed:

```

      IDE INTERFACE TEST VX.XX DEALER

Drive 4 is IDE
ADFS::4 is IDE drive 0
IDE drive : 0
Description : <aaaaa> <bbbbbb>
Firmware version : <cccc>
PASSED byte check

```

THIS SUB-TEST HAS PASSED

PRESS <SPACE BAR> to continue.

Note:

<aaaaa> Drive manufactures name (e.g. Conner Peripherals)

<bbbbbb> Drive model number (e.g. CP3044)

<cccc> Firmware version number (e.g. 2SA4.53)

Note that during the soak test the IDE drive interface test is not executed (see the section entitled *Performing soak tests* on page 1-17).

Action if the IDE hard disc drive fails

Check that the machine configuration is set for "IDEdiscs 1" and reset if necessary. Disassemble the computer using the procedure given in *Part 2 - Disassembly and assembly* and check the following:

- the 40 way data cable is securely connected to the drive and to PL9 on the main PCB.
- the 4 way power connector is correctly attached.

Try substituting a known working data cable for the existing cable and retest.

Using a voltmeter confirm that the following voltages appear on the 4 way power connector:

- 0V on pins 2 and 3 (black cable)
- 5V on pin 4 (red cable)
- +12V on pin 1 (yellow cable)

If a voltage is missing, check the crimps within the connector shell and repair if possible. If the problem is within the PSU then you must return this to an Acorn Authorised CSW.

Hardware check

The test continues by running a comparison check between the test data file and that which is fitted to the computer. The screen will clear and the following will be displayed:

```
COMPUTER TYPE TEST VX.XX DEALER

PASSED CPU version matches
PASSED MEMC version matches
PASSED OS version matches
PASSED Memory size matches
PASSED ST506 int. correct setup
PASSED ST506 ext. correct setup
PASSED IDE int. correct setup
PASSED Hard disc is correct size
PASSED FDC correct setup
PASSED Serial correct setup
PASSED Ethernet I correct setup
PASSED Ethernet II correct setup
PASSED SCSI Podule correct setup
PASSED ROM Podule correct setup
```

PRESS <SPACE BAR> TO CONTINUE

If the test fails, make a note of the fault and press the space bar.

The following will be displayed:

```
COMPUTER TYPE TEST VX.XX DEALER

PASSED UPM correct setup
PASSED I/O correct setup
PASSED I/O MIDI correct setup
PASSED MIDI correct setup
```

PRESS <SPACE BAR> TO CONTINUE

Action if hardware check fails

Check that the system matches the data file that you selected. A guide to the test data file can be to read the system variables that start:

```
Test_xxxx :y.
Test_Serial_port : 1 serial port
fitted.
```

If a module is fitted, the related test system variable should exist, the hardware check verifies this. If it is a version number check, then the hardware check compares the version number with the version fitted. The value attached to the string is only used in this test when checking version numbers or memory size. If the value is non-zero, it means the test is to be executed.

```
Test_MEMC_Version : 101 MEMC version
1a fitted
```

If the data file is correct, refer to the section entitled *Action if main PCB fails* on page 1-3.

External port tests

You should be familiar with the correct print-out pattern before running this test. It should resemble *Figure 1-3: Printer test output* shown overleaf.

While each test is being run the word Running will appear next to the test and then, when the test is complete, the pass/fail message will overwrite it.

The Printer test sends a test pattern to the printer. The pattern comprises a repeated series of stepped lines, each representing bits 0 to 7. You should look for a missing or corrupted pattern. As this is a subjective test make a note of any faults that you detect.

The RS423 port test is carried out automatically and gives a passed/failed message.

The screen will clear and the following will be displayed:

```
EXTERNAL PORTS TESTS VX.XX DEALER

Passed PRINTER, EPSON FX.
Passed Printer Graphic Test.
Passed Printer Text Test.
Passed SERIAL, 82C710 CHIP TEST.
Passed Control Line Test.
Passed Data Line Test.
Passed Communications State Test.
Passed Baud Rate Test.
NOT DOING ECONET PORT TEST
```

THIS SUB-TEST HAS PASSED

PRESS <SPACE BAR> TO CONTINUE

Check the printout.

Action if printer test fails

- Check that the configuration settings for PRINTER and IGNORE are correct.
- Check that the type of printer displayed matches the type used.
- Check that the printer is on line and that the printer lead is connected correctly and functions correctly.
- If the fault still persists then refer to the section entitled *Action if main PCB fails* on page 1-3.

Action if the RS423 tests fail

- Ensure that the configuration items BAUD and DATA are set to sensible values (see the *RISC OS User Guide*).
- If the test still fails, check that the correct loopback plug is fitted and that it functions correctly (this can be done by trying it on another unit).
- If the unit still fails, then refer to the section entitled *Action if main PCB fails* on page 1-3.

Note: During the soak tests neither the printer nor the RS423 tests are executed (see the section entitled *Performing soak tests* on page 1-17).

Figure 1-3: Printer test

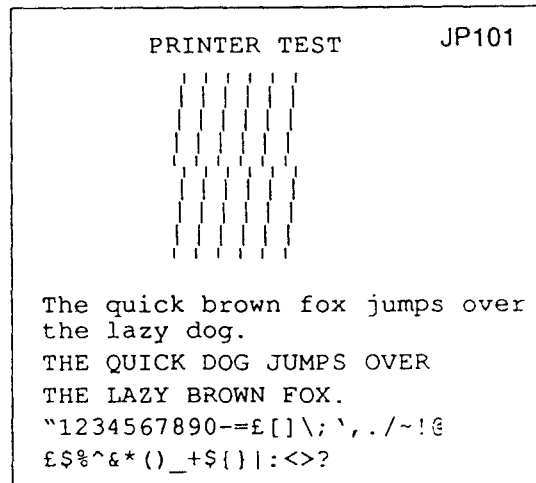
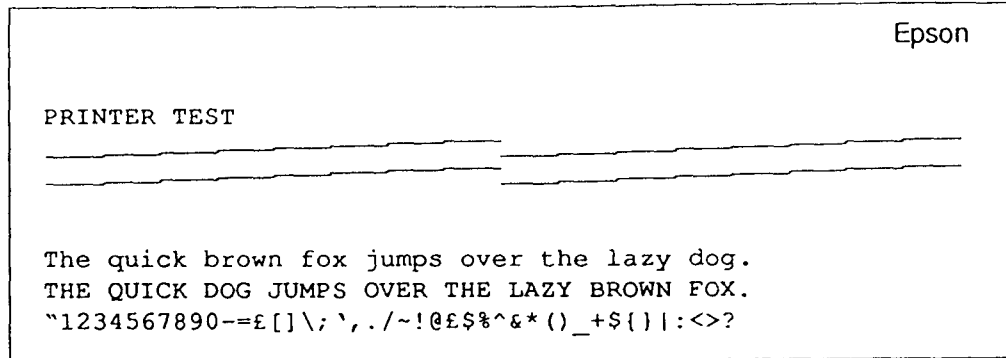

Disc interface test

The screen will clear and the following will be displayed:

```
FLOPPY DISC TEST VX.XX DEALER
Passed Write Protect Test.
Passed Verification Test.
Running Write Track Test 0, Drive 0
Remove the test disc from drive :0
Insert the BLANK DISC in drive :0
The BLANK DISC needs to be F Map
```

Insert the blank *scratch* disc, and the write track test continues, displaying the following on the screen:

```
Working Track 76 Sector 04 Head 00
Disc Address used &000BF000
```

The read track and erase track tests are now complete. When you are requested, put the test disc back in drive :0. Press the space bar to continue.

If the write protect test fails it will corrupt the test disc. You will then have to replace it with a new copy. A sign of this corruption is that a file called !DISC_FAIL will appear on the disc, and the disc will not boot.

If errors occur during the read test, a maximum of 12 read errors may occur per sector before the next sector is read. A total of 6 sectors are tested.

Note: During the soak tests only the write protect and verification tests are executed (see the section entitled *Performing soak tests* on page 1-17).

Action if floppy disc drive fails

If there is **no desktop icon**, check the CMOS RAM configuration for "floppies 1" and reset if necessary. Disassemble the machine (see *Part 2 - Disassembly and assembly*) and check that both the 34 way data cable and the 4 way power cable are securely connected at the rear of the drive. Also check that the data cable is connected to the main PCB at PL10.

Using a voltameter, check that 0V and +5V are present on the drive power cable and 0V on pins 2 and 3, +5V on pin 1 (conductor 1 is marked with white on the cable). If there is no power, inspect the crimps inside the connector shell and repair or replace if possible. If the failure is with the PSU itself, return it to an Acorn Authorised CSW for repair.

Check the data cable by substituting a known working cable and retesting.

Check that IC38 is located securely in its socket.

As a final measure, try substituting a known working floppy disc drive. Depending on the outcome of this test, return either the main PCB or the floppy drive to an Acorn Authorised CSW for repair.

If an icon is present but an error occurs during access, disassemble the machine and check that the 34 way data cable is correctly connected both at the rear of the drive and on the main PCB PL10.

Check the data cable by substituting a known working cable.

Also check that the main PCB links are set correctly. See *Appendix F - Main PCB links, plugs & sockets* for LK18, LK19 and LK21.

Try to format a new floppy disc and retest the drive by attempting to read the original disc on another machine. Note that if this fails the disc may be corrupted.

As a final measure, try substituting a known working floppy disc drive. Depending on the outcome of this test, return either the main PCB or the drive to an Authorised Acorn CSW for repair.

Real time test

The screen will clear and the following menu will be displayed:

```

TIME TEST VX.XX DEALER

1) CHECK THE DATE AND TIME
2) SET THE DATE AND TIME
3) CHECK THEN SET THE DATE AND TIME

Please select the required option ?

```

The normal procedure is to select option 1. If you want to reset the time or date you would select 2 or 3. For example, you can:

- type 1 to check the date and time
- check that the time is correct and the seconds are incrementing correctly.

Then either press F5 (if correct) or F8 (if not correct), and press the space bar to continue.

Action if real time test fails

If the test fails, refer to the section entitled *Action if main PCB fails* on page 1-3.

Audio tests

Note that the audio tests are subjective tests and that you should be familiar with the correct sounds before running the tests.

Speaker tests

The screen clears and the following menu is displayed:

```

SOUND TEST VX.XX DEALER

Running Loudspeaker Test
Listen and check sound quality

Stereo Output Channel

```

Flashing arrow heads (<<<<) will then point alternately left and right depending on the stereo channel being used.

The test consists of a repeating sequence of 8 musical notes.

- 1 Listen to the sequence of notes.
- 2 Check for any deviation from the known good sound, and ensure that a clean sound is being emitted from both channels.
- 3 Listen for any interference or background hissing from the speaker.

Press F5 if correct, or F8 if not correct, to continue. You cannot press a function key until at least one cycle of each sound channel is complete. If the test fails, refer to the following section entitled *Action if audio tests fail*.

Headphone tests

The headphone test is similar to the speaker test except that the sound is sent through the headphones. The same checks that are used for the loudspeaker test should be undertaken. The first four notes are played in one headphone and the next four notes in the other headphone.

The screen will then clear and the sound test results will be displayed. If the test fails, refer to the following section entitled *Action if audio tests fail*.

Action if audio tests fail

If it appears that the speaker alone is at fault, check the speaker connections. Ensure that the cable connecting the speaker to the PCB is in place. Also check the solder joints on the speaker tags and the two crimps in the shell. Repair any bad joints and try the tests again. For details of how to remove the speaker, refer to *Part 2 - Disassembly and assembly*.

If the headphones alone appear at fault, substitute a known working pair of headphones and retest.

Also check that the CMOS RAM configuration has not been set to mute the speaker and that the audio volume is set to an appropriate value.

If these actions fail to restore the audio system or the audio system is distorted or corrupted in some way, you must remove the main PCB and return it to an Acorn Authorised CSW.

Video tests

The display tests are subjective tests and you should be familiar with the correct screen displays before running these tests and make a note of any failures.

The screen will clear and the following will be displayed:

```

VIDEO TEST VX.XX DEALER

Running Standard Colour Tests

PRESS <SPACE BAR> to continue.

```

These tests consist of a series of screen displays. You proceed through the tests at your own pace. When you press the space bar the screen test will commence.

Standard colour test

The screen test displays four colour bars red, green, blue and grey scale. Each colour bar is divided into 6 sections. The number at the top of the screen is the value sent to the individual colour gun. Only one gun is driven at a time for the red, green, and blue bars. The grey scale bar is produced by equal amounts driving each of the colour guns.

Starting from the left, the first block is no units of colour, the next block contains a small amount of red (1 unit bit 0 set) the next more red (2 units - bit 1 set) continuing along until the block is a full red (15 units of red - all bits set). The left most three blocks are out-lined with rectangles of full colour. Check that the colour increases with each block, to full intensity on the right most block. This should be true for each colour bar.

The background is divided into two triangles; one brown and one grey/blue colour. Check the linearity of the dividing line and the colour of the triangles. A cursor is made up of three squares and passes across the screen from bottom left to top right. Also verify that the cursor contains three rectangular outlines in colours green, blue and red. Check the linearity of movement and also check the transparency of the cursor as it moves across the screen. Make sure that the colours do not change as the cursor moves across the screen. Verify the border colour.

Press F5 if the display is correct, or press F8 if not.

If the test fails, refer to the following section entitled *Action if video tests fail*.

High resolution monochrome display

This test is not done.

Press the space bar to continue.

Standard VGA display

The same display is used in a VGA mode as in the standard colour test. Repeat all the checks that were performed on the standard monitor test on the standard VGA display.

Note that the border is removed in the standard VGA tests.

Press F5 if the display is correct, or press F8 if not. If the test fails, refer to the following section entitled *Action if video tests fail*.

Super VGA display

You are presented with a screen display that contains 16 squares, made from shades of red, green, blue and grey. Check that the image is sharp, clear and stable on the screen.

Note that the border is removed in Super VGA tests.

Press F5 if the display is correct, or press F8 if not. If the test fails, refer to the following section entitled *Action if video tests fail*.

Action if video tests fail

If there is no display check that there is power on the monitor (green LED on) and that the brightness and contrast controls are sufficiently advanced. If a video cable adaptor is in use then make sure this corresponds to one of the types described in *Appendix E - Monitor adaptor cables*.

Check that the video loopback is functioning correctly by making sure that it works on a known working machine. Switch the machine off, hold down the key marked "." on the numeric keypad and switch the machine on holding down this key for at least a further 10 seconds. This has the effect of resetting the monitor configuration to match the type of monitor connected. If this fails to solve the problem then substitute a known good monitor and cable and try again.

If this action still fails to produce a display, remove the top cover of the computer (see *Part 2 - Disassembly and assembly*) and check on the main PCB that the shunts on LK6 pins 1 and 2 and LK6 pins 3 and 4 have not been dislodged. As a final action, remove the main PCB and return it to an Acorn Authorised CSW for repair.

If the display is corrupted, check the adaptor cable (if used) against those listed in *Appendix E - Monitor adaptor cables* and reset the monitor configuration via the power up "." process. Check the monitor and cable by substituting with known working items and repeat the power up "." process. If the fault proves to be with the main computer then you must return the main PCB to an Acorn Authorised CSW for repair.

Video configuration test

A pass/fail message is displayed after testing the video configuration circuitry.

This test will write data to the video loopback box via the printer port which will simulate different monitor types at the video socket. The monitor configuration is then checked.

Action if video configuration test fails

If the test fails, check that the correct data is being sent from the printer port by connecting the printer.

If the printer functions correctly, check that the monitor loopback box is working by replacing the box and cables.

If the video configuration test still fails with a known working printer port and monitor loopback box, return the main PCB to an Acorn Authorised CSW for repair.

Summary screen

At the end of the screen tests a final summary screen will be displayed.

Press the space bar to continue.

Keyboard and mouse tests

Note that for the mouse test you will need a mouse jig template to perform the test (see *Appendix A - Mouse test jig template*).

Reset button sub-test

During this test you are asked to press the Reset button to test the operation of the switch. If this button works, the program moves onto the next sub-test automatically.

If the test fails, refer to the section entitled *Action if keyboard fails* on page 1-15.

Stuck key sub-test

This sub-test tests for stuck keys or mouse buttons. If no items are found to be stuck, the test software moves onto the next test automatically without displaying any information.

If any keys or mouse buttons are stuck down, you will see the following screen display:

```
SOME KEYS ARE STUCK
```

```
Note the keys that are stuck, reject the
      keyboard or the mouse.
```

Press the Break key to continue and wait.

Press the Break key and the program moves to the Keyboard/Mouse report screen. Refer to the section entitled *Action if keyboard fails* on page 1-15.

Break and Escape key stuck sub-test

This sub-test tests if the Break or Escape keys are stuck down. If the keys are not stuck, the test software moves onto the next test automatically without displaying any information.

If the Break or Escape keys are stuck down, you will see the following message on the screen:

```
THE ESCAPE OR BREAK KEYS ARE STUCK
      DOWN. REPLACE THE KEYBOARD
```

Refer to the section entitled *Action if keyboard fails* on page 1-15.

Mouse sub-test

This tests the three buttons on the mouse and the movement of the mouse to the left, right, up and down. Each of the mouse buttons (i.e. left, middle, right) are displayed on the screen in turn, together with a pointer. You need a mouse test jig template to perform this test. See *Appendix A - Mouse test jig template*.

During this test the mouse is viewed with the cable coming out of the top of the mouse. Take care to ensure that the mouse does not 'skid' on the template when you move it.

- 1 The test starts by clearing the screen and asking you to position the mouse in the bottom left hand corner of the mouse test jig.
- 2 With the mouse in this position, press the middle key.

- 3 The screen is then cleared, and a rectangle is drawn in the bottom left hand corner with the word *Left* printed inside it. Do not move the mouse at this stage.
- 4 Press the left hand mouse key.
- 5 The screen will then clear, and you should move the mouse to the bottom right hand position on the test jig. Ensure the mouse does not skid on the jig as you move it.
- 6 As the mouse moves across the jig, a box will appear in the bottom right hand corner of the screen. When the mouse reaches the bottom right hand position on the jig, the pointer on the screen should be in the centre of the displayed box.
- 7 Press the right mouse button, when requested. A new box now appears in the top right hand corner.
- 8 Move the mouse to the top right hand position on the test jig. Again the screen pointer should appear in the centre of the displayed box when the mouse is in the top right hand position on the test jig.
- 9 Press the requested key.
- 10 Repeat this exercise for the two remaining positions.
 - If the pointer does not finish in the displayed box when the mouse is in the relevant test jig box, the test has failed.
 - If you press the wrong mouse button and the pointer is not in the rectangle, then nothing will happen.
 - If you accidentally press two buttons together, you will see both buttons displayed on the screen. The screen is displayed in inverse video and the depressed keys are displayed on the screen. Press the Break key to continue the test.
 - If you cannot make a button disappear then it will be impossible to continue the test.

If the test fails, refer to the following section *Action if mouse fails*.

If the mouse is functioning correctly, the program moves on to the next test.

Action if mouse fails

Check that you are testing the correct mouse type by reading the data file, or by referring to the keyboard main menu screen. Ensure that the configuration setting for MouseStep (0) is correct.

If, when you pressed the requested mouse button, nothing happens or the program repeatedly claims that two keys were pressed or the pointer will not move, then substitute a known working mouse of the same type and retest. This determines if the fault is within the mouse itself or the keyboard's mouse interface. If the fault is within the keyboard, refer to the section entitled *Action if keyboard fails* on page 1-15.

Check that roller ball is not sticking, in which case you can remove and clean it. If the mouse still fails then return it to an Acorn Authorised CSW for repair.

Main keyboard sub-test

For this sub-test, the display clears and the main keyboard matrix is displayed with the following title at the top of the screen:

Main Keyboard Test

Press each key in turn, starting at the bottom left (Caps lock) moving across to the bottom right (Ctrl) key, then up a line to the left hand Shift key.

As you move across the keyboard pressing the keys in the correct order, the key that is pressed should disappear from the display. The test continues in this way until all the keys up to the function key F12 have been tested.

If you press the wrong key nothing will happen. If you press two keys (the correct key and one other) the screen is shown in inverse video and the depressed keys are shown on the screen. If a key fails to disappear after three attempts, the program displays a failure message at the top of the screen and then prompts you to press the Break key. The program then exits to the Keyboard/ Mouse report screen. Refer to the section entitled *Action if keyboard fails* on page 1-15.

If the keyboard functions correctly, the program moves onto the next test.

Numeric keypad sub-test

For the numeric keypad sub-test, the display clears and the cursor and numeric key matrixes are displayed on the screen. The two key matrixes are tested separately: first the cursor keys, then the text editing keys, and then the Print, Scroll Lock and Break keys.

Finally the numeric matrix is tested, starting with the 0 key and working along the matrix in the same pattern as before, finishing with the # key.

If you press the wrong key, nothing will happen. If you press two keys, this is highlighted in inverse video. If a key fails to disappear after three attempts, the program displays a failure message at the top of the screen, and then prompts you to press the Break key. The program then exits to the Keyboard/ Mouse report screen. Refer to the section entitled *Action if keyboard fails* on page 1-15. If the keyboard functions correctly, the program moves onto the next test.

Keyboard LED sub-test

This test checks that the LEDs on Caps Lock, Scroll Lock and Num Lock are working.

The screen clears and the following is displayed:

```
Running Keyboard LED Tests
CHECK <CAPS LOCK> LED IS ON
```

- 1 Check that the caps lock keyboard LED is the only LED on, the other two are extinguished.
- 2 Press F5 to PASS or F8 to FAIL the test (do this for each subsequent LED test). Check the caps lock is extinguished, hence all keyboard LEDs are off.

- 3 This test is repeated for the remaining two keyboard LEDs, the display giving you suitable prompts. Note any LED failures before continuing with the next test.

This is a subjective test. If the test fails, refer to the following section entitled *Action if keyboard fails*.

Keyboard/mouse report screen

At the end of a successful test the following screen is displayed:

```
KEYBOARD & MOUSE TEST VX.XX DEALER

PASSED Logitech Mouse Test
PASSED Reset Button Test
PASSED Stuck Keys Test
PASSED Keyboard LED Test
PASSED Main keyboard Test
PASSED Numeric Keypad Test

PASSED MOUSE TEST
PASSED KEYBOARD TEST

THIS SUB_TEST HAS PASSED
PRESS <SPACE BAR> TO CONTINUE
```

The message that the keyboard has passed the sub-test refers only to the non-subjective test elements and should not be interpreted as an overall pass, since you may wish to fail the UUT on a subjective test element.

Note: During the soak test neither the keyboard nor the mouse tests are executed (see the section entitled *Performing soak tests* on page 1-17).

Action if keyboard fails

Substitute the existing keyboard for a known working keyboard and retest.

If the fault lies with the original keyboard, disassemble the keyboard unit (see *Part 2 - Disassembly and assembly*) and inspect the keyboard PCB for damage, loose sockets, stuck keys etc. If you cannot find any obvious fault, return the keyboard PCB (not the entire keyboard) to an Acorn Authorised CSW for repair.

If the working keyboard fails, disassemble the computer case (see *Part 2 - Disassembly and assembly*) and inspect the main PCB for the correct positioning of the following shunts:

- LK1 shunt between pins 1 and 2
- LK2 shunt between pins 1 and 2
- LK4 shunt between pins 1 and 2
- LK5 shunt between pins 2 and 3

If these are correct then remove the main system PCB and return it to an Acorn Authorised CSW for repair.

Test report

At the end of this sequence of tests, a report screen shows the status of the tests.

```

REPORTS VX.XX DEALER

PASSED   Hardware Check
PASSED   Memory Test
PASSED   Floppy Disc Test
PASSED   Keyboard Test
PASSED   CMOS RAM Test
PASSED   Time Test
PASSED   Mouse Test
PASSED   Parallel Port Test
PASSED   Serial Port Test
PASSED   Sound Test
PASSED   Video Test
PASSED   IDE Interface Test

TESTS PASSED : 1 Loop completed

PRESS <SPACE BAR> TO CONTINUE

```

A list of the test pass/fail results are displayed, allowing you to note any failures. If any failures occurred, repair the UUT if possible and start the test procedure again.

The hard disc (if fitted) is parked ready for the UUT to be powered down.

If you would like to perform additional individual tests on the unit, such as the hard disc exerciser and hard disc reformatter, refer to the following section entitled *Additional individual tests*. Otherwise go to the section entitled *After the tests* on page 1-17.

Additional individual tests

You can also access the following individual tests from the main test menu:

- expansion card tests
- PCB module tests

Note: The expansion card tests are not described in this manual but are documented separately in the notes accompanying each individual expansion card.

Select option B from the main test menu:

```

MENU VX.XX UN-DEF

(A) Test Suite
(B) Individual Tests
(C) Load / Save CMOS
(D) Quit

```

Select the test type of your choice

You will see the following menu displayed on the screen:

```

Individual Tests

(A) Exp-Cards
(B) Pcb-Module

```

Select option B for a full list of the available individual tests. The hard disc exerciser and hard disc formatter are included in this list and are described in the following sections.

Hard disc exerciser

Select the Hard Disc Exerciser option from the list of individual tests. This program exercises the hard disc by creating 20 random data files on the disc. It then performs various operations on these files. A pass completion screen is displayed, similar to that shown below:

```

SCSI WINCHESTER EXERCISER

Operations 4000

          Pass  Fail          Pass  Fail
File 1   104          File B    57
File 2    98          File C    70
File 3   166          File D    75
File 4   157          File E    89
File 5    86          File F    77
File 6    48          File 10   98
File 7    98          File 11  181
File 8    80          File 12  103
File 9   112          File 14   93
File A    85          File 15  114
Disc Op. : 0 Commands : 0

```

The values given to Disc Op. and Commands are 8 bit patterns decoded to be the following:

```

Disc Op.
Bit 7,6,5 Not used
Bit 4      Read Failure
Bit 3      Write Failure
Bit 2      Failed trying to close file

Commands
Bit 7      Fail try to load dummy file
Bit 6      Compact Failed
Bit 5      Verify Failed
Bit 4      Free Failed
Bit 3      Map Failed
Bit 2      CAT Failed
Bit 1      not used
Bit 0      not used

```

If you have finished testing, follow the instructions in the section entitled *After the tests* on page 1-17. If you would like to format the IDE hard disc, follow the procedure given in the next section.

Hard disc formatter

WARNING:
THIS TEST WILL WRITE TO THE IDE HARD DISC. YOU SHOULD FIT A TEST HARD DISC (SEE THE SECTION *Creating a test IDE hard disc* ON PAGE 1-6) OR ALTERNATIVELY ENSURE THAT THE CUSTOMER IS AWARE THAT THEIR HARD DISC WILL BE OVERWRITTEN, AND HAS GIVEN THEIR CONSENT BEFORE YOU START.

Select the Hard Disc Formatter option from the menu which lists the individual tests. Note that the figures given in the following example are for illustration only and vary according to the model of hard disc drive.

When you run the hard disc formatter program, the screen clears and the following information is displayed:

```

H A R D D I S C F O R M A T T E R
Format which drive (4-7)? 4
Drive 4 is an IDE drive
IDE drive ADFS:4 identifies itself as :
Description      : <manufacturer's name,
model no.>
Firmware Version : <Version no.>
Configuration   : < ? cylinders, ?
heads and ? sectors/track>
This disc was last formatted using the
standard shape :
<manufacturer's name, model no.>
750 Cylinders, 8 Heads and 17
Sectors/Track
Parking cylinder xxx, Initialisation
flag 1
Do you wish to use this shape (Y/N) ? N
Do you wish to use the standard shape
for this drive (Y/N) ? Y
  A: no more changes
  B: add defect by cylinder, head,
    byte/sector
  C: add defect by disc address
  D: remove defect
  A,B,C, or D ? A
Disc will be formatted as
<manufacturer's name, model no.>
750 Cylinders, 8 Heads and 17
Sectors/Track
Parking cylinder xxx, Initialisation
flag 1
Format or just initialise the drive
(F/I) ? I
Soak test the hard disc for defects
(Long/Short/None) ? S
Are you SURE you want to do this to
drive ADFS:4 (Y/N) ? Y
Verifying
Large file allocation unit? 512
Writing defect list
Creating map
Writing map
Writing root directory
Bytes free &031D6400 = 52257792
Bytes Used &00008C00 = 35840

PRESS <SPACE BAR> TO CONTINUE

```

After the tests

At the end of the functional test suite, we recommend that you:

- perform the soak tests
- perform the safety tests
- retest the unit

See *Figure 1-4: Procedure after repair overleaf* for an overview of this procedure.

Also, before returning the computer to the customer, you must perform the following tasks using the procedures described in this section:

- restore the CMOS RAM settings
- replace the customer's hard disc (if necessary)
- switch off the equipment
- disconnect the equipment

Performing soak tests

At the end of the test suite or individual test, we recommend that you carry out a soak test on the UUT. Once the soak test has finished, it is advisable to run the full sequence of tests on the computer again before returning it to the customer.

To perform a soak test, leave the unit under test powered up for eight hours, or alternatively, overnight. To run the soak tests, select option A from the main test menu.

```
MENU VX.XX UN-DEF
```

- ```

(A) Test Suite
(B) Individual Tests
(C) Load / Save CMOS
(D) Quit

```

Select the test type of your choice

Select the 'A5000' option from the next menu and the computer displays the following list of choices:

- ```

(A) A5000 1Mb Fun. Test
(B) A5000 1Mb Soak Test
(C) A5000 2Mb + HD Fun. Test
(D) A5000 2Mb + HD Soak Test

```

Press * to quit - for top menu

Select the soak test option that is correct for the configuration of the machine.

Performing safety tests

Once you have proved that the UUT functions correctly, you must perform the safety tests described in *Appendix C - Earth continuity testing* and *Appendix D - DC insulation testing - class 1*.

If either the earth continuity test or the DC insulation test fails, take steps to fix the fault. If the problem lies with the PSU, return it to an Acorn Authorised CSW for repair.

Retesting the unit

On successful completion of the soak test, we recommend that you retest the computer using the full functional test suite.

Figure 1-4: Procedure after repair

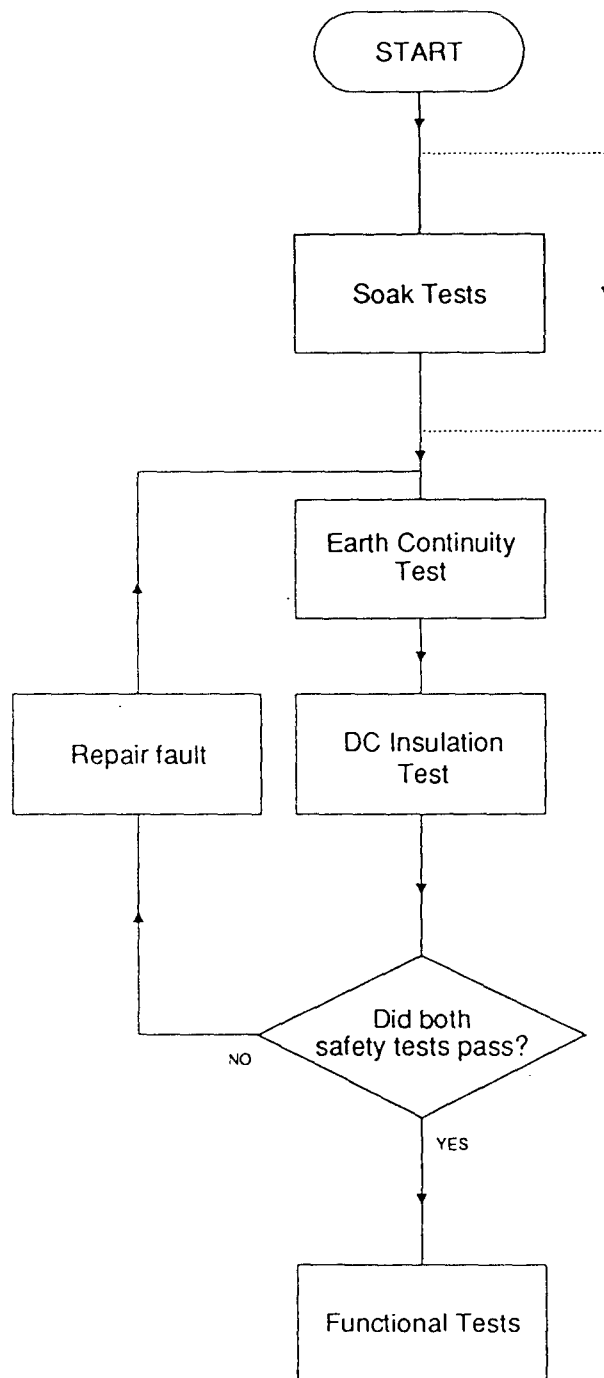

————— Recommended route
- - - - - Possible route

Restoring the CMOS RAM settings

When you have finished testing, you need to restore the customer's original CMOS RAM settings:

- 1 Press the Shift and Break keys simultaneously. This produces the top level menu:

```
MENU VX.XX UN-DEF
```

- (A) Test Suite
- (B) Individual Tests
- (C) Load / Save CMOS
- (D) Quit

Select the test type of your choice

- 2 Select option (C) Load / Save CMOS. This produces the following menu:

```
LOAD / SAVE CMOS RAM VX.XX UN-DEF
```

- 1. Save CMOS RAM to disc.
- 2. Load CMOS RAM from disc.
- 3. Exit Program.

Please select the required option ?

- 3 Select option 2, and replace the test disc in the floppy drive with the data disc which holds the stored CMOS RAM settings.
- 4 When prompted, enter the filename (including the full directory path if necessary) that contains the customer's CMOS RAM configuration settings. Press Return.
- 5 Remove the data disc when prompted.
- 6 Press the space bar to continue.
- 7 Type 3 to exit the program.

Replacing the customer's hard disc

If you created and fitted a test IDE hard disc, you need to replace it with the customer's original hard disc. To do this follow the instructions given below:

- 1 Replace the test hard disc with the original hard disc, using the procedure given in *Part 2 - Disassembly and assembly*.
- 2 Check the refitted hard disc starts up properly – power up the equipment, click the mouse over the hard disc icon and ensure a directory viewer appears.

Switching off the equipment

If you have completed service or tests on the system and are about to move the computer and/or return it to the customer, you **must** do the following **before** switching off:

- 1 Shutdown the unit under test:
 - press F12 and type SHUTDOWN (then press Return)
 - or
 - select **Shutdown** from the Task Manager menu.
 this parks the hard disc heads, if a hard disc drive is fitted.

- 2 Switch off the power to the computer (at the mains switch on the front of the machine).
- 3 Switch off the power to the rest of the equipment.

Disconnecting the equipment

It is important to disconnect the equipment from the computer in the correct order:

- 1 Disconnect the Archimedes computer from the mains supply.
- 2 Disconnect all monitors from the mains supply.
- 3 Disconnect all other equipment from the mains supply.
- 4 Disconnect all monitors from the Archimedes computer.
- 5 Disconnect the headphones from the headphones socket.
- 6 Disconnect the printer from the Parallel Printer port.
- 7 Disconnect the serial port loopback plug from the RS423 socket.
- 8 Disconnect the keyboard from the front panel connector.
- 9 Disconnect all other test equipment from the computer.

Packing

After servicing, repack the computer in its box. To avoid damage, do **not** send the computer through the post or by courier unless it is in its original packaging.

Part 2 - Disassembly and assembly

DANGER:

BEFORE REMOVING THE TOP COVER, ENSURE THAT THE COMPUTER SYSTEM HAS BEEN SWITCHED OFF AND THE MAINS PLUG REMOVED FROM THE SUPPLY. REMOVING THE TOP COVER GIVES ACCESS TO THE POWER SUPPLY. ALTHOUGH THE POWER SUPPLY IS DESIGNED TO COMPLY WITH BS5850 CLASS 1, YOU MUST STILL TAKE CARE TO ENSURE THAT NO METAL OBJECTS FALL (OR ARE PUT) INTO THE POWER SUPPLY UNIT THROUGH THE VENTILATION HOLES.

NOTE:

STRINGENT ANTI-STATIC PRECAUTIONS MUST BE TAKEN ONCE YOU HAVE REMOVED THE TOP COVER.

Introduction

This chapter tells you how to break down a standard A5000 computer into its serviceable modules, in order to carry out basic checks and replace modules found to be faulty.

It is recommended that you remove modules in the order given in this chapter, to ensure, for instance, that no cables are left connected to the particular item you wish to remove.

The main unit houses the following:

- Backplane*
- Main PCB
- 3.5" floppy disc drive
- Hard disc drive*
- Speaker
- Power supply unit (PSU).

*Hard disc drive models only

The keyboard, mouse and monitor are separate units. See the appropriate third-party service information for the monitor. The mouse is a service replacement only item. This chapter makes reference (when it gives item numbers) to the final assembly drawing (part number 0092,100/A) which you will find at the back of this manual. Also see *Appendix G - Final assembly parts list* for a list of part numbers.

Removing the top cover

- 1 Shutdown the computer using one of the following two methods:
 - press F12 and type SHUTDOWN (then press Return)
 - select **Shutdown** from the Task Manager menu
 This shuts the computer down correctly and parks the hard disc, if a hard disc drive is fitted.
- 2 Switch off and disconnect the computer from the mains supply and then disconnect all peripherals, including the keyboard.

- 3 Place the main unit on a work surface with a clean, soft covering and turn it over so that it rests on its top cover.
- 4 Remove the six fixing screws (item 46) on the underside of the main unit.

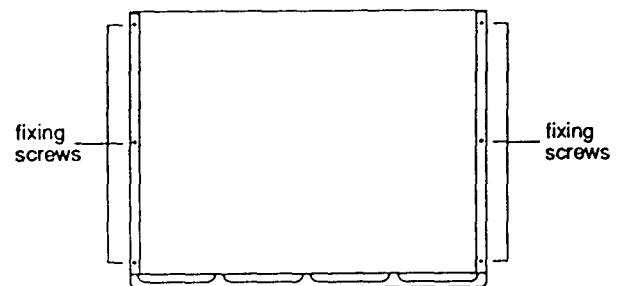

front of computer

- 5 Rest the main unit on its base again and slide the lid (item 24) backwards to the rear of the unit. Remove the lid completely.

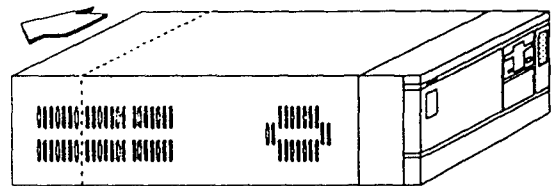

- 6 Some models of the A5000 have an EMC case shield (item 29) which fits over the case. To remove this shield, unscrew the five fixing screws on the right hand side of the unit, as seen from the rear. The shield has interleaved tabs which fit into the edges of the case. Slide the shield off the main unit carefully; there is a hole on the top to help you slide the shield off by inserting a screwdriver.

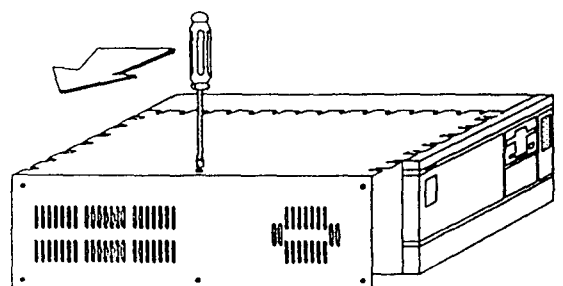

Removing the backplane

Note that the backplane is only fitted on models with a hard disc drive.

The backplane (item 9) sits inside the main unit, attached to the main PCB and the backplane/drive tray (item 25).

- 1 Remove the four fixing screws from the backplane.
- 2 Remove the backplane from the main board connector SK9 by pulling the backplane upwards.

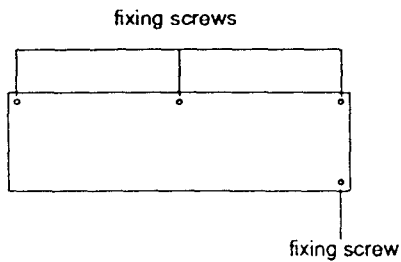

Removing cables

- 1 Disconnect the following cables from the main PCB which sits inside the main unit:

- the six power connections to the PCB, PL2 to PL7
- the speaker connection LK8
- the LED connection LK22
- the floppy disc drive data cable connection PL10
- the hard disc drive data cable connection PL9

If the computer does not have a hard drive, ignore the above reference to the hard disc data cable.

Removing the main PCB

- 1 Some models of the A5000 have two fixing screws which attach the PCB to the base metal work. One screw is located near SK3, the other can be found near SK8. Remove these screws from the PCB.
- 2 The rear panel of the computer is attached to the PCB. Unscrew the two fixing screws on this panel. Note that some models of the computer have an EMC gasket sandwiched between the rear panel and the PCB.

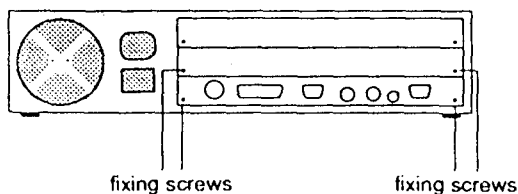

- 3 Unscrew the two fixing screws on the lower blanking panel and remove this panel, together with the gasket shield (item 26). It is easier to slide out the PCB once you have removed this panel.
- 4 The main PCB is positioned within four side slide guides (item 5), two at each side. To extract the PCB assembly, lift the rear panel slightly and slide the PCB out along the slide guides towards the rear of the main unit and out through the rear panel opening. Take care not to damage the gasket fingers that are attached to the rear panel on some models of the A5000.

Note: Observe all anti-static precautions when storing the PCB.

Removing the disc drives

If your computer does not have a hard disc drive, ignore all references to this item.

- 1 Remove the power connection from the hard disc drive (item 78) which runs to the PSU (item 12).
- 2 Remove the power connection from the floppy disc drive (item 77) which runs to the PSU.
- 3 Remove the W-shaped EMC spring clip (which earths the floppy drive to the main case) by pressing down and hooking it out. See the diagram below.

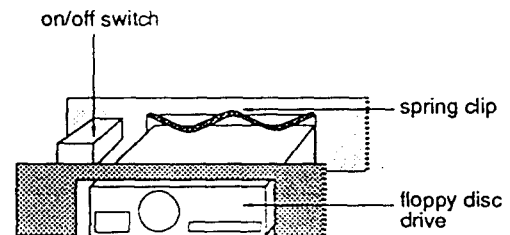

- 4 Undo the fixing screw which holds the backplane/drive support tray (item 25), as shown in the following diagram.

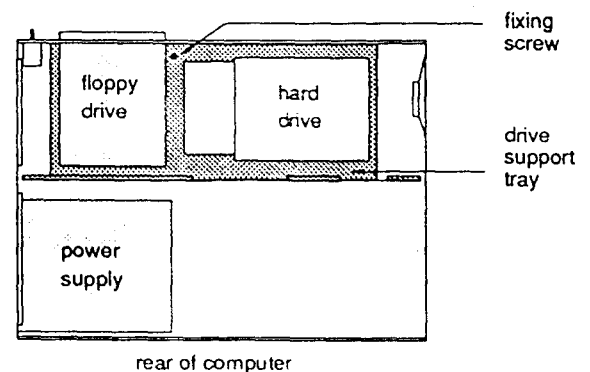

- 5 The tray has two tabs which fit into the front slots of the unit and four clips, two at each side, holding the tray in place. Remove the tray from the main unit by grasping both ends of the support metalwork. The whole assembly should lift and the end tags disengage from the sides. See the diagram below.

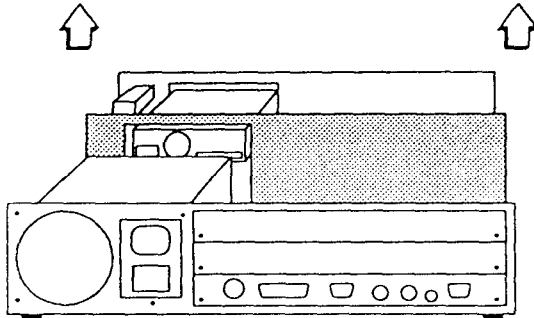

- 6 Once you have removed the tray, you can remove the floppy disc drive (item 77) and the hard disc drive (item 78) by turning the tray over and unscrewing the four screws which hold each drive in place. Take care to observe all anti-static precautions when storing the disc drives.

Removing the speaker

Looking from the rear of the main unit, the speaker (item 36) is located on the right hand side of the unit.

- 1 Remove the rubber sealant (item 74) from each side of the speaker.
- 2 Pull the speaker directly upwards and out of the main unit.

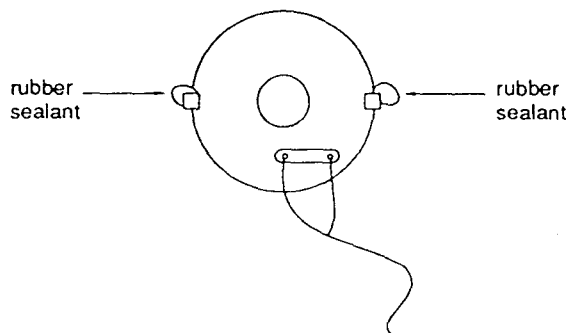

Removing the front plastic moulding

- 1 There are six spring plastic clips on the front moulding (item 28), three each on the top and bottom, attaching it to the main unit. Release these clips from the inside of the main unit.
- 2 Remove the plastic moulding. Note that there are two LEDs in the front moulding, with wires attached. Feed these wires carefully through the plastic panel.

Removing the power supply unit

- 1 Remove the plastic push button from the on/off switch (item 32) on the front of the unit.
- 2 Undo the two fixing screws on each side of the on/off switch socket.

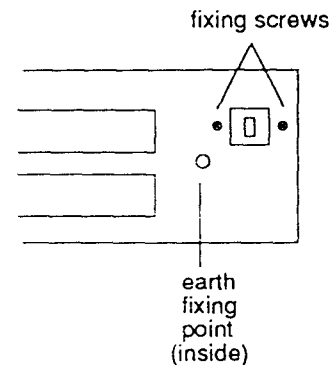

- 3 Remove the earth wire from the earth fixing point, easing the wire away from the harness clip at the side of the unit.
- 4 The power supply unit itself (item 12) is held in place by two screws which fix it to the base metal work of the unit. Remove these two fixing screws together with their washers.

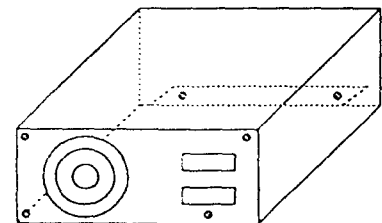

- 5 Remove the four fixing screws at the rear of the unit.
- 6 Lift the power supply unit upwards and out of the main unit.

Main unit assembly

DANGER:

WHEN REFITTING OR FITTING A REPLACEMENT ASSEMBLY, CHECKS SHOULD BE MADE FOR EARTH CONTINUITY AND FOR DC INSULATION.

FOR DETAILS REFER TO *Appendix C - Earth continuity testing* AND *Appendix D - DC insulation testing - class 1*.

NOTE THAT THE PSU IS A SERVICE REPLACEMENT ONLY ITEM.

Assembly is generally the reverse of the disassembly procedures, but take care with the routing of cables and ensure that leads are not trapped when refitting assemblies to the main unit. The following points are also worth noting when you assemble the computer.

Power supply unit

When installing the PSU, the system should be tested for satisfactory earth continuity in accordance with BS7002/EN60950 and DC insulation.

Ensure that you refit the earth wire exactly as shown in detail B of the final assembly drawing (part number 0092/100/A), which you will find at the back of this manual.

Also make sure that you connect the faston power connections to the main PCB in the correct order, which is as follows:

PL2	-5V	purple wire
PL3	+12V	yellow wire
PL4	0V	black wire
PL5	0V	black wire
PL6	+5V	red wire
PL7	+5V	red wire

Speaker

When refitting the speaker, ensure that you replace the rubber sealant (item 74) on each side of the speaker.

Disc drives

When refitting the backplane/drive support tray, note that the tray has two tabs which slot into the front of the main unit and four clips, two at each side, holding the tray in place. Ensure that the two tabs on the tray slide fully into the slots at the front of the unit. If they are not completely in place, there is a risk of damage to the disc drives when the unit is moved.

PCB

On some models of the A5000, care is needed when assembling the main PCB to avoid damaging the EMC gasket. As you slide the PCB board into the main unit lift the rear panel, to ease the gasket fingers over the back edge of the unit.

Keyboard

The computer may be fitted with either one of two keyboards:

- Panasonic (fitted on most models)
- Keytronic (on some early models).

Both keyboards are identical on the exterior; they only differ internally, in that they have different PCBs.

Disassembly

- 1 Invert the keyboard and place it on a soft, level surface.
- 2 Remove the eight cross-headed screws securing the two halves of the case and carefully lift the base moulding away.
- 3 The PCB in the Keytronic keyboard is fixed to the top moulding by six No. 6 x 0.25" screws.
The PCB in the Panasonic keyboard is fixed to the top moulding directly by four screws, and also by means of two metal brackets (with four screws and washers).
For the Panasonic keyboard, first remove the two screws and washers fixing the brackets to the top moulding, then remove the remaining screws fixing the PCB directly to the moulding (you can leave the brackets attached to the PCB).
For the Keytronic keyboard, remove the six screws fixing the PCB to the top moulding.
- 4 Note that the reset switch cap must be removed from the original keyboard and fitted to the replacement.

Assembly

Keyboard assembly is generally in reverse order, with the following notes:

Slot the PCB support tray under the two fixing screws at the end furthest from the keyboard cable, then insert the remaining screws. Check that all keys clear the cutouts in the top moulding before finally tightening all PCB fixing screws.

Mouse

The mouse is a service replacement only item.

Appendix A - Mouse test jig template

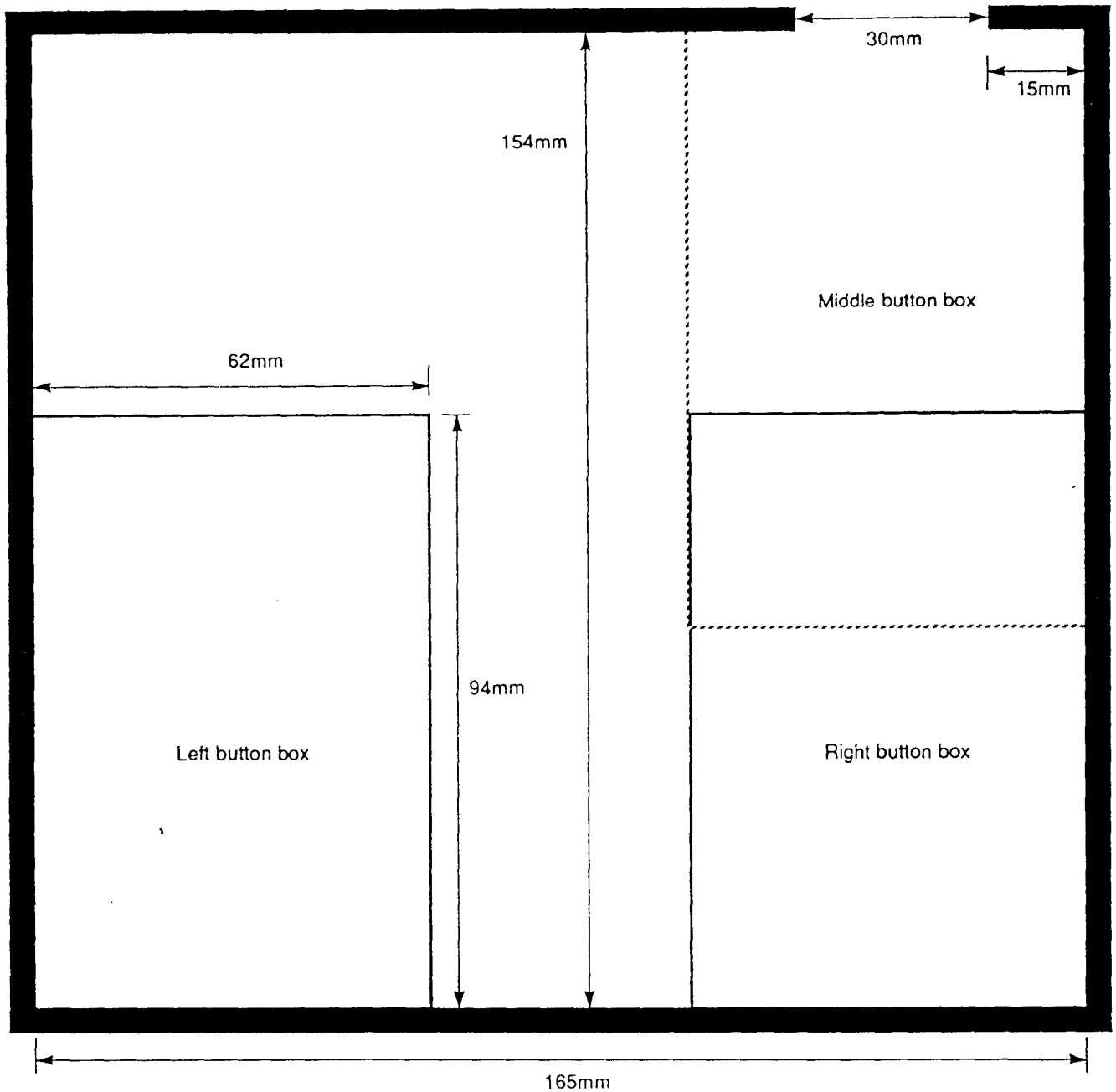

- 1 Using wood or metal strips, construct a test jig with the dimensions shown in the template (plan view) above.
- 2 Secure the test jig to a firm, flat, horizontal, non-slip surface.
- 3 Mark out the three button boxes shown on the template.

Notes:

- The INSIDE dimensions of the jig are important.
- The sides of the jig should be LESS than 5mm high.
- The Middle and Right button boxes overlap.

Mouse in middle
button box

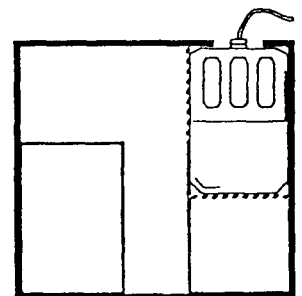

Appendix B - Serial port loopback plug

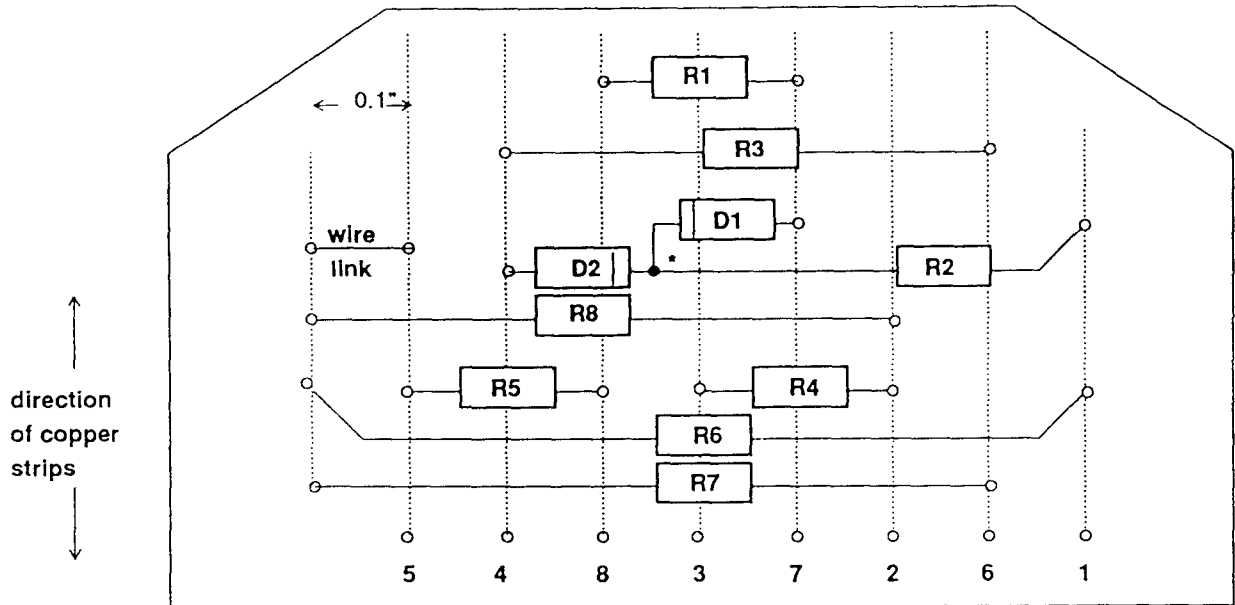

○ hole

* components join above the board surface

Assembly notes

Assemble the components onto Veroboard, and fit item 5 (the shell) to protect the assembly.

Item	Part no.	Description	Qty
1	0276,081	CIRCUIT & ASSEMBLY DRAWING	1*
3	0800,288	CONR 9W SCKT 'D' ST MS SB	1
5	0800,991	CONR 9W SHELL 'D' + SCREWS	1
R1	0502,122	RES 1K2 C/MF 5% 0W25	1
R2	0502,122	RES 1K2 C/MF 5% 0W25	1
R3	0502,122	RES 1K2 C/MF 5% 0W25	1
R4	0502,122	RES 1K2 C/MF 5% 0W25	1
R5	0502,472	RES 4K7 C/MF 5% 0W25	1
R6			N/F
R7	0502,472	RES 4K7 C/MF 5% 0W25	1
R8	0502,472	RES 4K7 C/MF 5% 0W25	1
D1	0790,085	DIODE BAT85 SBL	1
D1	0790,085	DIODE BAT85 SBL	1

* per batch

Appendix C - Earth continuity testing

Equipment required

An earth continuity tester or appliance tester capable of sourcing 8-25A derived from an AC source with a no-load voltage not exceeding 12V, for example, CLARE A433R-IO.

It is recommended that the calibration and operation of the instrument is checked frequently enough to ensure its accuracy.

DANGER:

THE FOLLOWING TESTS INVOLVE HIGH CURRENTS BUT LOW VOLTAGES. ALL NECESSARY PRECAUTIONS MUST BE TAKEN TO ENSURE OPERATOR SAFETY DURING TESTING.

DANGER:

SWITCH OFF THE COMPUTER, DISCONNECT IT FROM THE MAINS SUPPLY, AND DISCONNECT ANY EXTERNAL PERIPHERALS AND CABLES BEFORE CARRYING OUT THIS TEST.

WARNING:

DO NOT MOVE THE TEST PROBE WHILST APPLYING THE TEST CURRENT.

Before testing

Check the mains lead and plug for any physical damage and replace if necessary.

WARNING:

YOU MUST NOT ALLOW THE TEST PROBE TO TOUCH ANY OF THE CONNECTORS' SIGNAL PINS AS THIS WILL DAMAGE THE EQUIPMENT.

Test procedure

Consult the instructions supplied with the test equipment. The test should be performed on a fully assembled computer and the equipment must be tested with the mains lead it will be operated with.

Using the Earth continuity tester, check the continuity between the power supply cord plug earth/ground pin and the following points:-

- 1 the chassis upper wrap
(Note that if you need to remove the paint from the upper wrap in order to make a good connection, do this in a place where it will not be visible to the customer. We recommend an area within the cooling slots on the side of the upper wrap.)
- 2 the lower wrap (metalwork) on the base of the unit
- 3 the rear panel fixing screws (six screws)
- 4 the fixing bolts for
 - printer/parallel port (D-type)
 - Analogue RGB port (D-type)
 - any other expansion cards (eg SCSI).

The resistance measured between the earth pin and each of the above test points shall not exceed 0.15 Ω . This value includes an allowance for the resistance of the mains cable. The duration of each test shall not exceed 10 seconds. No waiting period between tests is necessary.

Earth continuity test points

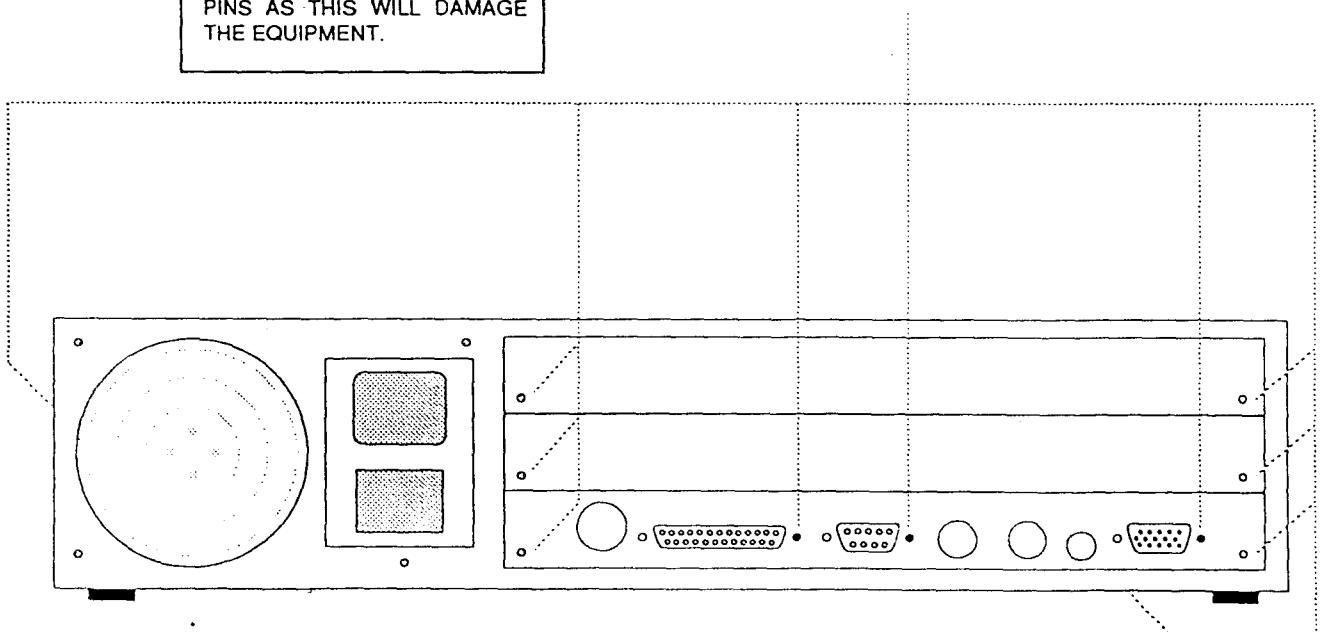

Appendix D - DC insulation testing - class 1

UK information only

Equipment required

A portable appliance tester or an insulation tester that provides 500V DC ONLY.

Note that the computer contains RFI capacitors on the PSU input.

It is recommended that the calibration and operation of the instrument is checked frequently enough to ensure its accuracy.

DANGER:

THE FOLLOWING TEST INVOLVES HIGH VOLTAGES. ALL NECESSARY PRECAUTIONS MUST BE TAKEN TO ENSURE OPERATOR SAFETY DURING TESTING. NOTE THAT THE OPERATOR MUST BE TRAINED AND COMPETENT.

DANGER:

SWITCH OFF THE COMPUTER, DISCONNECT IT FROM THE MAINS SUPPLY, AND DISCONNECT ANY EXTERNAL PERIPHERALS AND CABLES BEFORE CARRYING OUT THIS TEST.

Before testing

Check the mains lead and plug for any physical damage and replace if necessary.

Test procedure

Consult the instructions supplied with the test equipment. The test should be performed on a fully assembled computer.

The equipment must be tested with the mains lead it will be operated with.

- 1 Insert the mains lead either into the portable appliance tester, or into an adaptor, as shown below.
- 2 Move the computer's power switch to the ON position.
- 3 Apply the test voltage for LESS than 10 (TEN) seconds and then measure the resistance.
- 4 Pass level: GREATER than 2 (TWO) MΩ.
- 5 Move the computer's power switch to the OFF position and remove the mains lead from the portable appliance tester.

Testing with an insulation tester

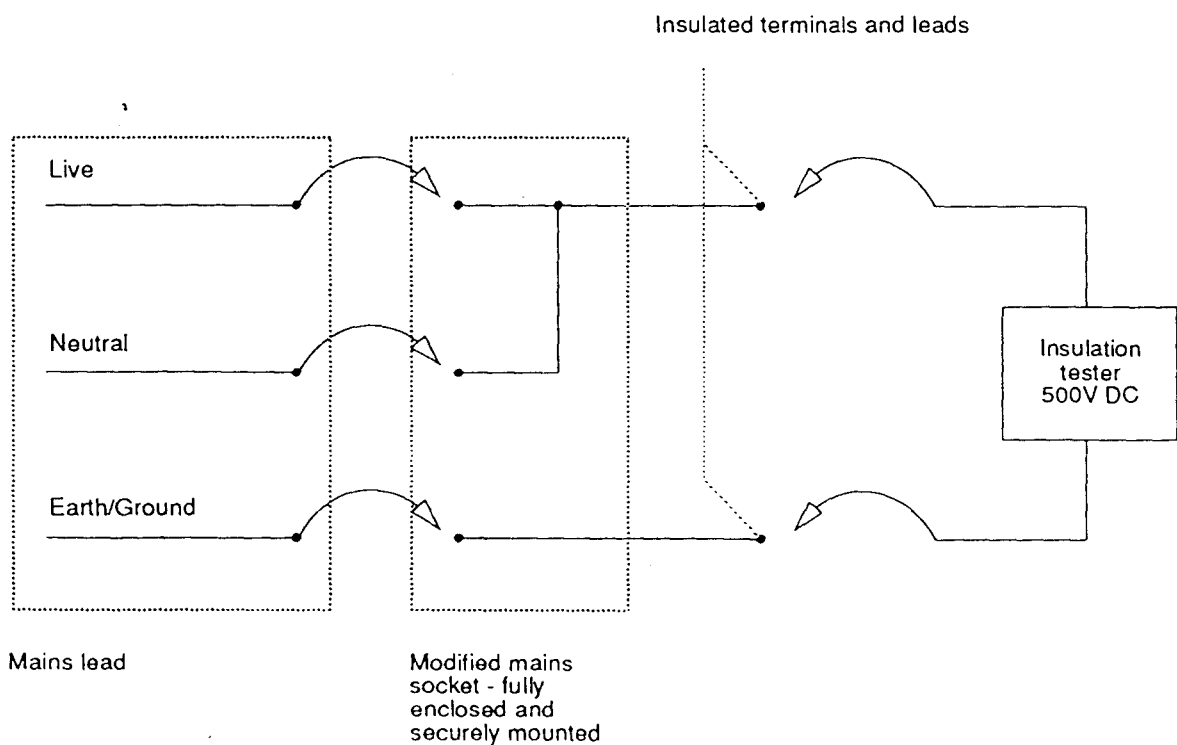

Appendix E - Monitor adaptor cables

This appendix describes how to make adaptor cables for monitors not supplied with a 15-way VGA connector.

Adaptor type 1

The cable supplied with some Multiscan monitors is terminated at the computer end with a 9-way D-type plug. You need a standard 15-way plug to 9-way socket adaptor:

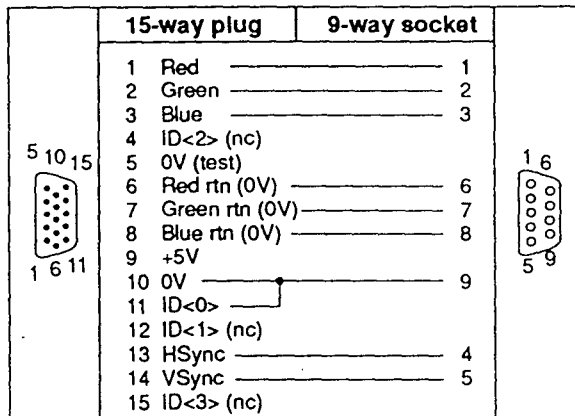

Note: The ID[0] to 0V connection will make the monitor type 3 modes available and the computer will generate separate sync signals.

Most Multiscan monitors are now being designed to be VGA-compatible and will work satisfactorily when driven with separate horizontal and vertical sync signals.

Adaptor type 2

The cable supplied with some Multiscan monitors requiring composite sync is terminated at the computer end with a 9 pin D-type plug. You need a 15-way plug to 9-way socket adaptor:

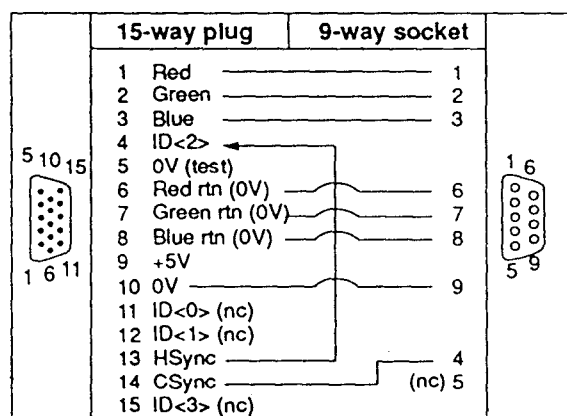

Note: The HSYNC to ID[2] connection will make the monitor type 1 modes available and the computer will generate a composite sync signal.

Adaptor type 3

The cable supplied with some TV-type monitors is terminated at the computer end with a 9 pin D-type plug. You need a 15-way plug to 9-way socket adaptor:

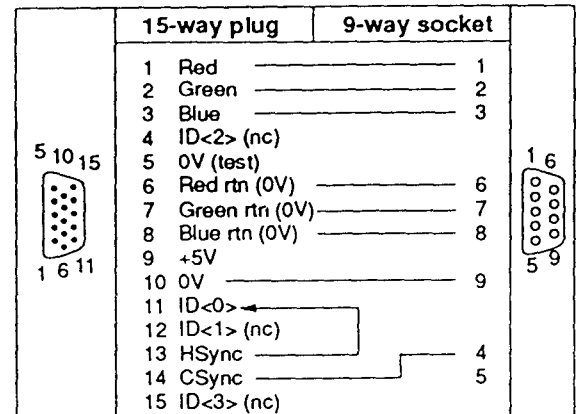

Note: The HSYNC to ID[0] connection will make the monitor type 0 modes available and the computer will generate a composite sync signal.

Cable type 4

You need to make this cable to use with televisions and TV-type monitors using a SCART input socket:

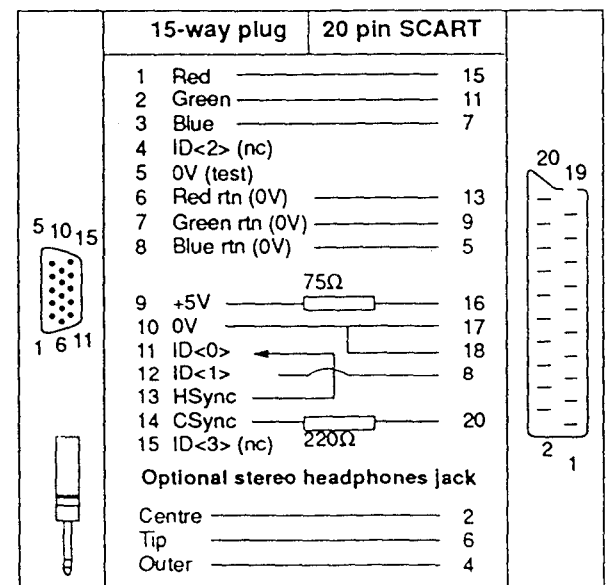

The 220Ω resistor results in a CSYNC signal of approximately 1V peak on pin 20 of the SCART connector. The 75Ω resistor results in a blanking signal of approximately 2.5V dc on pin 16 of the SCART connector.

Cable type 5

You need to make this cable to use with monochrome monitors which have a phono input socket. You need a 15-way plug to phono socket adaptor with resistors, to mix the separate red, green and blue signals into a composite monochrome signal (you can fit these components into a 15-way connector shell).

You need to make an adaptor cable that has a 15-way D-type plug on one end, and a phono plug on the other. The connections you need to make are as follows:

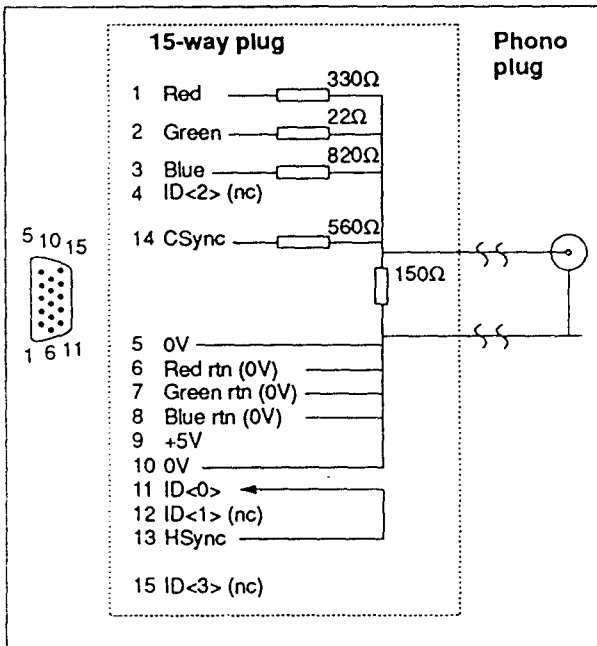

Note: The HSYNC to ID[0] connection will make the monitor type 0 modes available and the computer will generate a composite sync signal.

Appendix F - Main PCB links, plugs & sockets

Introduction

This appendix describes the links, plugs and sockets on the main PCB of the A5000 computer.

Links

Link	Fitted	Effect	Default
LK1	Yes	Used to select signal options for pin5 of keyboard socket (SK4). Sig. option LK1 PC Kbd dock 2-3 KIN data 1-2	Shunt 1-2
LK2	Yes	Used to select the signal source to pin 6 of the keyboard socket (SK4). 1-2 inverted Kout from IOC 2-3 logic 1	Shunt 1-2
LK3	Yes	Internal auxiliary audio connector providing access to the following signals: P1 Unfiltered Left P2 0V P3 Left Phones P4 0V P5 Aux Input P6 0V P7 Right Phones P8 0V P9 Unfiltered Right P10 0V	None
LK4	Yes	Used to select signal options for pin 1 of keyboard socket (SK4). Sig. option LK4 PC bidirectional data 2-3 reset from Kbd 1-2	Shunt 1-2
LK5	Yes	Used to select the source of "Keyboard In" data for IOC. 1-2 Keyboard in data (from controller (IC6) 2-3 Kin data from keyboard	Shunt 2-3
LK6	Yes	Genlock connection point: P1 Internal video clock P9 VED2* P2 Clock to VIDC P10 VED3* P3 SINK P11 SUPREM-ACY* P4 0V P12 HI* P5 nc P13 HSYNC* P6 nc P14 VS* P7 VED0* P15 0V P8 VED1* P16 0V	Shunt 1-2 Shunt 3-4

Link	Fitted	Effect	Default
LK8	Yes	Connection point for the internal speaker: P1 0V P2 Signal	None
LK9	Yes	Test connector used in conjunction with Acorn designed test equipment: P1 5V P2 D[0] P3 LA[21] P4 TESTAK P5 RST* P6 0V	None
LK10	Yes	Used to select ROM TYPE: TYPE Non JEDEC 512K 1-2 3-4 Non JEDEC 1MB ROM 1-2 3-4 Non JEDEC 1MB EPROMs JEDEC 1, 2, 4, and 8MB ROMs and EPROMs 1-3 2-4	Shunt 1-3 Shunt 2-4
LK11	Yes	Used in conjunction with LK14 and LK12 to select ROM SIZE: SIZE (Bits) LK14 LK11 LK12 1M 2-3 2-3 2-3 2M 1-2 2-3 2-3 4M 1-2 1-2 2-3 8M 1-2 1-2 1-2	Shunt 1-2
LK12	Yes	See LK11.	Shunt 2-3
LK13	No	Used to select the source of Parallel port Interrupt for IOEB 1-2 parallel port ACK* signal 2-3 PINTR* from 82C710	1-2
LK14	Yes	See LK11.	Shunt 1-2
LK15	Yes	Used to select '5th column' ROM size (JEDEC only device). Size (bits) LK15 up to 1M 2-3 2M 1-2	Shunt 1-2
LK17	Yes	Used to select Normal or Alternate pre-compensation scheme for floppy drive interface Pre-comp LK17 Normal (125ns @ 500kb/s) (125ns @ 250kb/s) 1-2 Alt (125 ns @ 500kb/s) (250 ns @ 250kb/s) None	None
LK18	Yes	Used to select the polarity of the Mode select signal routed to pin 3 of LK19. Polarity LK18 PC-AT 1-2 PS/2 2-3	Shunt 1-2

Link	Fitted	Effect	Default
LK19	Yes	Used in conjunction with LK18 to select the function of pin 2 of the Floppy disc drive data connector B (PL11). P1 DISC CHANGE I/P on 82C710 P2 Pin 2 of disc drive connector P3 MODE SELECT (polarity depends on LK18)	Shunt 2-3
LK21	Yes	Used to connect pin 34 of floppy drive connector B (PL11) to the DISC CHANGE I/P of 82C710 P1 DISC CHANGE I/P on 82C710 P2 Pin 34 of drive connector P3 nc	Shunt 1-2
LK22	Yes	Connection for Power and Hard disc activity LEDs. P1 HD LED (-) P2 HD LED (+) P3 Power LED (-) P4 Power LED (+)	None
LK23	Yes	Used in conjunction with LK24 to select various combinations of DRAM on the main PCB and the memory upgrade card. Total DRAM DRAM on PCB DRAM on U/G card LK23 LK24	None
		1M 1M - nc nc 2M 2M - nc 2-3 4M 4M - nc 1-2 2M 1M 1M nc 2-3 4M 1M 3M 1-2 2-3 4M 2M 2M 1-2 2-3	
LK24	Yes	See LK23. 1MB machine nc 2MB machine 2-3 4MB machine 1-2	Model-dependent

Plugs

Plug	Fitted	Function/Specification
PL1	Yes	Serial Port. (IBM PC-AT Pinout) 9-way D-type plug. Pin Signal Pin Signal 1 DCD 6 DSR 2 Rx/D 7 RTS 3 Tx/D 8 CTS 4 DTR 9 RI 5 0V
PL2 to PL6		Power supply connectors. PL2 -5V PL6 +5V PL3 +12V PL7 +5V PL4 0V PL5 0V

Plug	Fitted	Function/Specification
PL8	No	Floppy disc power connector. P1 +5V P2 0V P3 0V P4 nc
PL9	Yes	IDE hard disc drive data connector. This is a 40 way box-header containing all the signals required by the drive in AT mode. Pin Signal Pin Signal 1 RST* 2 0V 3 DATA7 4 DATA8 5 DATA6 6 DATA9 7 DATA5 8 DATA10 9 DATA4 10 DATA11 11 DATA3 12 DATA12 13 DATA2 14 DATA13 15 DATA1 16 DATA14 17 DATA0 18 DATA15 19 0V 20 nc 21 nc 22 0V 23 IOW* 24 0V 25 IOR* 26 0V 27 IORDY* 28 nc 29 nc 30 0V 31 IRQ 32 IO16* 33 LA[3] 34 PDIAG* 35 LA[2] 36 LA[4] 37 CS0* 38 CS1* 39 SLV/ACT 40 0V
PL10	Yes	Floppy Disc Drive Data Connector A. This is a 34-way Box Header containing all the signals required by the internal floppy disc drive(s). Pin Signal Pin Signal 2 MODE SELECT 20 STEP* 4 nc 22 WRITE DATA* 6 nc 24 WRITE GATE* 8 INDEX* 26 TRACK0* 10 DRIVE SELECT 0* 28 WRITEPROTECT* 12 DRIVE SELECT 1* 30 READ DATA* 14 nc 32 SIDE1* 16 MOTORON* 34 DISC CHANGE 18 DIRIN*
		* All signals are active low. 3,13,15,17,19,21,23,25,27,29,31,33 all 0V 5,7,9,11.
PL11	Yes	Floppy Disc Drive Data Connector B. This is a 34-way Box Header containing all the signals required by a variety of internal/external drives. Pin Signal Pin Signal 2 See Note 20 STEP* 4 nc 22 WRITE DATA* 6 nc 24 WRITE GATE* 8 INDEX* 26 TRACK 0* 10 DRIVE SELECT 2* 28 WRITEPROTECT* 12 DRIVE SELECT 3* 30 READ DATA* 14 nc 32 SIDE1* 16 MOTORON* 34 See Note 18 DIRIN*
		* All signals are active low. 3,13,15,17,19,21,23,25,27,29,31,33 all 0V 5,7,9,11. Note: Pins 2 and 34 have several functions, depending on the positions of LK19, 18 & 21.

Sockets

Sket	Fitted	Function/Specification																																																
SK1	Yes	<p>RGB video socket.</p> <p>This is a 15-way mini D-type socket providing an interface to RGB monitors and Scart TVs.</p> <p>RGB video levels are 0.7V Pk-Pk into 75 Ohm. Sync voltage levels are $\geq 2.0V$ (TTL).</p> <table> <thead> <tr> <th>Pin</th> <th>Signal</th> </tr> </thead> <tbody> <tr><td>1</td><td>RED</td></tr> <tr><td>2</td><td>GREEN</td></tr> <tr><td>3</td><td>BLUE</td></tr> <tr><td>4</td><td>ID[2]</td></tr> <tr><td>5</td><td>0V</td></tr> <tr><td>6,7,8</td><td>0V</td></tr> <tr><td>9</td><td>+5V (750mA fuse)</td></tr> <tr><td>10</td><td>0V</td></tr> <tr><td>11</td><td>ID[0]</td></tr> <tr><td>12</td><td>ID[1]/SCART func. switching</td></tr> <tr><td>13</td><td>HSYNC</td></tr> <tr><td>14</td><td>VSYNC/CSYNC</td></tr> <tr><td>15</td><td>ID[3]</td></tr> </tbody> </table>	Pin	Signal	1	RED	2	GREEN	3	BLUE	4	ID[2]	5	0V	6,7,8	0V	9	+5V (750mA fuse)	10	0V	11	ID[0]	12	ID[1]/SCART func. switching	13	HSYNC	14	VSYNC/CSYNC	15	ID[3]																				
Pin	Signal																																																	
1	RED																																																	
2	GREEN																																																	
3	BLUE																																																	
4	ID[2]																																																	
5	0V																																																	
6,7,8	0V																																																	
9	+5V (750mA fuse)																																																	
10	0V																																																	
11	ID[0]																																																	
12	ID[1]/SCART func. switching																																																	
13	HSYNC																																																	
14	VSYNC/CSYNC																																																	
15	ID[3]																																																	
SK2	Yes	<p>Stereo headphone output.</p> <p>This is a 3-way 3.5mm stereo jack socket providing output to "Walkman-type" 32 ohm stereo headphones.</p>																																																
SK3	No	9-way mini-DIN providing connection for quadrature mouse. Reserved for future use.																																																
SK4	Yes	6-way mini-DIN socket providing the connection point for the keyboard.																																																
SK5	Yes	<p>Parallel printer port.</p> <p>25-way D-type socket providing a parallel printer interface.</p> <table> <thead> <tr> <th>Pin</th> <th>Signal</th> <th>Pin</th> <th>Signal</th> <th>Pin</th> <th>Signal</th> </tr> </thead> <tbody> <tr><td>1</td><td>STB*</td><td>8</td><td>PD[6]</td><td>15</td><td>ERROR*</td></tr> <tr><td>2</td><td>PD[0]</td><td>9</td><td>PD[7]</td><td>16</td><td>INIT*</td></tr> <tr><td>3</td><td>PD[1]</td><td>10</td><td>ACK*</td><td>17</td><td>SLCTIN*</td></tr> <tr><td>4</td><td>PD[2]</td><td>11</td><td>BSY</td><td>18-25</td><td>0V</td></tr> <tr><td>5</td><td>PD[3]</td><td>12</td><td>PE</td><td></td><td></td></tr> <tr><td>6</td><td>PD[4]</td><td>13</td><td>SLCT</td><td></td><td></td></tr> <tr><td>7</td><td>PD[5]</td><td>14</td><td>AUTOFD*</td><td></td><td></td></tr> </tbody> </table>	Pin	Signal	Pin	Signal	Pin	Signal	1	STB*	8	PD[6]	15	ERROR*	2	PD[0]	9	PD[7]	16	INIT*	3	PD[1]	10	ACK*	17	SLCTIN*	4	PD[2]	11	BSY	18-25	0V	5	PD[3]	12	PE			6	PD[4]	13	SLCT			7	PD[5]	14	AUTOFD*		
Pin	Signal	Pin	Signal	Pin	Signal																																													
1	STB*	8	PD[6]	15	ERROR*																																													
2	PD[0]	9	PD[7]	16	INIT*																																													
3	PD[1]	10	ACK*	17	SLCTIN*																																													
4	PD[2]	11	BSY	18-25	0V																																													
5	PD[3]	12	PE																																															
6	PD[4]	13	SLCT																																															
7	PD[5]	14	AUTOFD*																																															
SK6	Yes	<p>Econet socket.</p> <p>5-way DIN socket for connection to Econet LAN. Note, this is an upgrade.</p> <table> <thead> <tr> <th>Pin</th> <th>Signal</th> </tr> </thead> <tbody> <tr><td>1</td><td>DATA</td></tr> <tr><td>2</td><td>0V</td></tr> <tr><td>3</td><td>CLOCK*</td></tr> <tr><td>4</td><td>DATA*</td></tr> <tr><td>5</td><td>CLOCK</td></tr> </tbody> </table>	Pin	Signal	1	DATA	2	0V	3	CLOCK*	4	DATA*	5	CLOCK																																				
Pin	Signal																																																	
1	DATA																																																	
2	0V																																																	
3	CLOCK*																																																	
4	DATA*																																																	
5	CLOCK																																																	
SK7	Yes	<p>Econet upgrade module socket.</p> <p>17-way header used in conjunction with SK8 to provide the electrical connection point for the internal Econet upgrade module. This module is identical to that used on Acom Master series and Archimedes computers.</p>																																																
SK8	Yes	<p>Econet upgrade module socket.</p> <p>5-way header used in conjunction with SK7.</p>																																																
SK9	Yes	<p>Backplane socket.</p> <p>Systems are normally supplied with a 4-way backplane already installed.</p>																																																
SK10	Yes	Mem expansion socket (1, 2 or 3MB upgrade)																																																

Appendix G - Final assembly parts list

Introduction

The parts list in this appendix details the components used in the final assembly of the Acorn A5000 computer. These components, together with their corresponding part numbers, are illustrated in the final assembly drawing given at the end of this manual.

Final assembly (Hard and floppy disc versions)

Note: Items in bold are only in the hard disc machine.

Item	Description	Qty
1	FINAL ASSY DRG (1 PER BATCH)	1
4	DOUBLE BLANKING PANEL	2
5	PCB SIDE SLIDE GUIDE	4
6	'NO ECONET' LABEL	1
9	BACKPLANE (4W) PCB BoM	1
12	BRISBANE (240V) PSU	1
16	FRONT LABEL	1
17	BASE LABEL	1
19	PSU IEC "IN" LABEL	1
20	PSU IEC "OUT" LABEL	1
23	LOWER CASE	1
24	UPPER WRAP	1
25	BACKPLANE/DRIVE TRAY	1
26	DOUBLE MODULE EMC GASKET*	2
28	FRONT MOULDING	1
29	CASE EMC SHIELD*	1
30	FLOPPY APERTURE COVER	1
31	BLANKING PANEL - FLOPPY	1
32	PLASTIC PUSH BUTTON	1
34	LED CABLE ASSEMBLY	1
35	DISC DRIVE CABLE ASSY	1
36	SPEAKER CABLE ASSEMBLY	1
39	MAIN (2M) PCB BoM	1
40	HARD DISC CABLE ASSY	1
45	SCW M2.5x6 PAN HD POSI Use on Items 4,26,39.	6
46	SCW M3x6 PAN HD POSI Use on Items 9,12,24,29,30,77.	25
48		
49	NUT M4 STL FULL Z/PASS Use on Item 23.	2
53	WSHR M3.5 PLN STL Z/PASS Use on Item 12.	4
54	WSHR M2.5 PLN STL Z/PASS Use on Items 4,26,39.	6
56	WSHR M3 SPRF IT STL Use on Item 12.	2
58	WSHR M4 SPRF IT STL Use on Item 23.	2
62	RIVET POP 3,2DIA x 6,41L Use on Item 5.	4
65	SPCR NYL 8mm PCB GAP 1END Use on Item 39. (Option) PCB SPACER 8mm	1
69	SCW6-32UNCx1/4" PAN POSI Use on Items 12,78.	8
73	FOOT PUSHFIT 21Dx4,2H	4
74	ADH MATL RUBR SEALANT Use on Item 34,36.	A/R
76	LABEL SERIAL No GP 50x15	1
77	FLOPPY DRIVE 1/2 MB 3.5"	1
78	WINI DRIVE 40MB 3.5" IDE {Caution when handling}	1

* Not fitted on early models of the A5000.

Reader's Comment Form

A5000 Module Level Service Manual

We would greatly appreciate your comments about this Manual, which will be taken into account for the next issue:

Did you find the information you wanted?

Do you like the way the information is presented?

General comments:

If there is not enough room for your comments, please continue overleaf

Name:

Name of organisation:

Nature of business:

Address:

Cut out (or photocopy) and post to:

Dept RC, Technical Publications
Acom Computers Limited
645 Newmarket Road
Cambridge CB5 8PB
England

This information will only be used to get in touch with you in case we wish to explore your comments further

