

Insulated Gate Bipolar Transistor Protected Logic-Level IGBT

BUK866-400 IZ

GENERAL DESCRIPTION

Protected N-channel logic-level insulated gate bipolar power transistor in a plastic envelope suitable for surface mount applications. It is intended for automotive ignition applications, and has integral zener diodes providing active collector voltage clamping and ESD protection up to 2 kV.

QUICK REFERENCE DATA

SYMBOL	PARAMETER	MIN.	TYP.	MAX.	UNIT
$V_{(CL)CER}$	Collector-emitter clamp voltage	350	400	500	V
V_{CEsat}	Collector-emitter on-state voltage			2.2	V
I_C	Collector current (DC)			20	A
P_{tot}	Total power dissipation			100	W
E_{CERS}	Clamped energy dissipation			300	mJ

PINNING - SOT404

PIN	DESCRIPTION
1	gate
2	collector
3	emitter
tab	collector

PIN CONFIGURATION

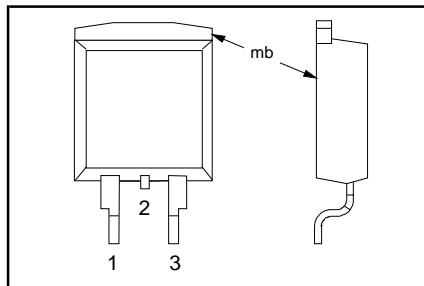

SYMBOL

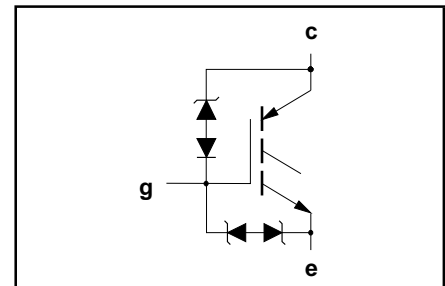

LIMITING VALUES

Limiting values in accordance with the Absolute Maximum System (IEC 134)

SYMBOL	PARAMETER	CONDITIONS	MIN.	MAX.	UNIT
V_{CE}	Collector-emitter voltage	$t_p \leq 500 \mu s$	-	500	V
V_{CE}	Collector-emitter voltage	Continuous	-20	50	V
$\pm V_{GE}$	Gate-emitter voltage	-	-	12	V
I_C	Collector current (DC)	$T_{mb} = 100 \text{ }^\circ\text{C}$	-	10	A
I_C	Collector current (DC)	$T_{mb} = 25 \text{ }^\circ\text{C}$	-	20	A
I_{CM}	Collector current (pulsed peak value, on-state)	$T_{mb} = 25 \text{ }^\circ\text{C}; t_p \leq 10 \text{ ms}; V_{CE} \leq 15 \text{ V}$	-	25	A
I_{CLM}	Collector current (clamped inductive load)	$1 \text{ k}\Omega \leq R_G \leq 10 \text{ k}\Omega$	-	10	A
E_{CERS}	Clamped turn-off energy (non-repetitive)	$T_{mb} = 25 \text{ }^\circ\text{C}; I_C = 10 \text{ A}; R_G = 1 \text{ k}\Omega$; see Figs. 23,24	-	300	mJ
E_{CERR}	Clamped turn-off energy (repetitive)	$T_{mb} = 125 \text{ }^\circ\text{C}; I_C = 8 \text{ A}; R_G = 1 \text{ k}\Omega$; $f = 50 \text{ Hz}; t = 60 \text{ min.}$	-	125	mJ
E_{ECR}	Reverse avalanche energy (repetitive)	$I_E = 1 \text{ A}; f = 50 \text{ Hz}$	-	5	mJ
P_{tot}	Total power dissipation	$T_{mb} = 25 \text{ }^\circ\text{C}$	-	125	W
T_{stg}	Storage temperature	-	-55	150	$^\circ\text{C}$
T_j	Operating Junction Temperature	-	-40	150	$^\circ\text{C}$

ESD LIMITING VALUE

SYMBOL	PARAMETER	CONDITIONS	MIN.	MAX.	UNIT
V_C	Electrostatic discharge capacitor voltage	Human body model (100 pF, 1.5 k Ω)	-	2	kV

Insulated Gate Bipolar Transistor Protected Logic-Level IGBT

BUK866-400 IZ

THERMAL RESISTANCES

SYMBOL	PARAMETER	CONDITIONS	TYP.	MAX.	UNIT
$R_{th\ j-mb}$	Thermal resistance junction to mounting base	-	-	1.0	K/W
$R_{th\ j-a}$	Thermal resistance junction to ambient	minimum footprint, FR4 board (see Fig. 26).	50	-	K/W

STATIC CHARACTERISTICS

$T_{mb} = 25\text{ °C}$ unless otherwise specified

SYMBOL	PARAMETER	CONDITIONS	MIN.	TYP.	MAX.	UNIT
$V_{(BR)CG}$	Collector-gate zener breakdown voltage	$2\text{ mA} \leq -I_G \leq 5\text{ mA}$; $-40 \leq T_j \leq 150\text{ °C}$	350	400	500	V
$V_{(BR)EC}$	Reverse collector-emitter breakdown voltage	$I_E = 10\text{ mA}$	20	30	50	V
$\pm V_{(BR)GES}$	Gate-emitter breakdown voltage	$I_G = \pm 1\text{ mA}$	12	16	20	V
$V_{GE(TO)}$	Gate threshold voltage	$V_{CE} = V_{GE}$; $I_C = 1\text{ mA}$	1	1.5	2	V
$V_{GE(TO)}$	Gate threshold voltage	$V_{CE} = V_{GE}$; $I_C = 1\text{ mA}$; $-40 \leq T_j \leq 150\text{ °C}$	0.6	-	2.4	V
I_{CES}	Zero gate voltage collector current	$V_{CE} = 50\text{ V}$; $V_{GE} = 0\text{ V}$; $T_j = 25\text{ °C}$	-	0.01	10	μA
I_{CES}	Zero gate voltage collector current	$T_j = 125\text{ °C}$	-	0.01	1	mA
I_{EC}	Reverse collector current	$V_{CE} = -20\text{ V}$	-	0.2	5	mA
I_{EC}	Reverse collector current	$V_{CE} = -20\text{ V}$; $T_j = 125\text{ °C}$	-	2	20	mA
I_{GES}	Gate emitter leakage current	$V_{GE} = \pm 6\text{ V}$; $T_j = 150\text{ °C}$	-	0.1	1	μA
V_{CEsat}	Collector-emitter on-state voltage	$V_{GE} = 4.5\text{ V}$; $I_C = 8\text{ A}$; $V_{GE} = 3.5\text{ V}$; $I_C = 6\text{ A}$; $-40 \leq T_j \leq 150\text{ °C}$	-	1.2	2.2	V
			-	1.2	2.2	V

DYNAMIC CHARACTERISTICS

$T_{mb} = 25\text{ °C}$ unless otherwise specified

SYMBOL	PARAMETER	CONDITIONS	MIN.	TYP.	MAX.	UNIT
$V_{(CL)CER}$	Collector-emitter clamp voltage (peak value)	$R_G = 1\text{ k}\Omega$; $I_C = 10\text{ A}$; $-40 \leq T_j \leq 150\text{ °C}$; Inductive load; see Figs. 23,24	350	400	500	V
g_{fe}	Forward transconductance	$V_{CE} = 15\text{ V}$; $I_C = 4\text{ A}$	5.5	15	20	S
C_{ies}	Input capacitance	$V_{GE} = 0\text{ V}$; $V_{CE} = 25\text{ V}$; $f = 1\text{ MHz}$	-	940	1200	pF
C_{oes}	Output capacitance		-	95	130	pF
C_{res}	Feedback capacitance		-	30	50	pF
$t_{d\ off}$	Turn-off delay time	$I_C = 8\text{ A}$; $V_{CL} = 300\text{ V}$; $R_G = 1\text{ k}\Omega$;	-	13	18	μs
t_f	Fall time	$V_{GE} = 5\text{ V}$; $T_j = 125\text{ °C}$;	-	6	10	μs
t_c	Crossover Time	Inductive load; see Figs. 20,21	-	12	-	μs
E_{off}	Turn-off Energy loss		-	13	-	mJ

Insulated Gate Bipolar Transistor
Protected Logic-Level IGBT

BUK866-400 IZ

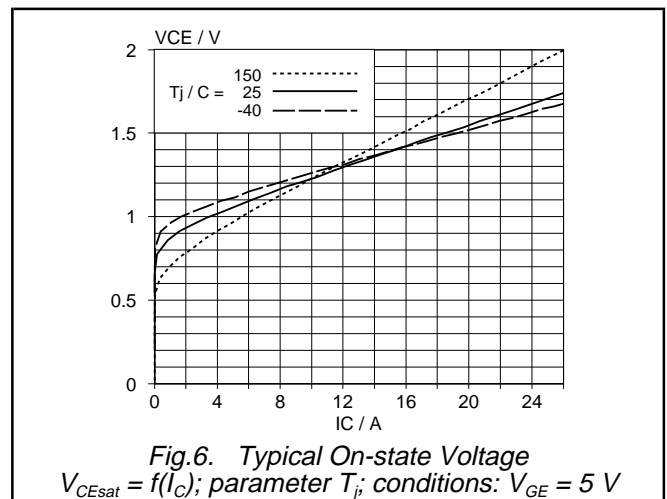
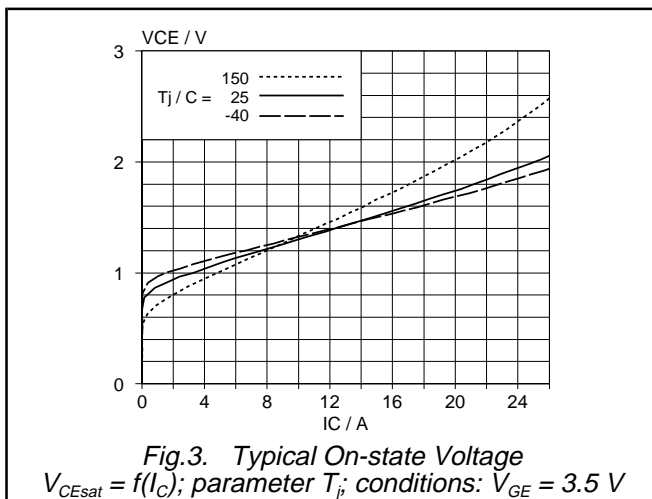
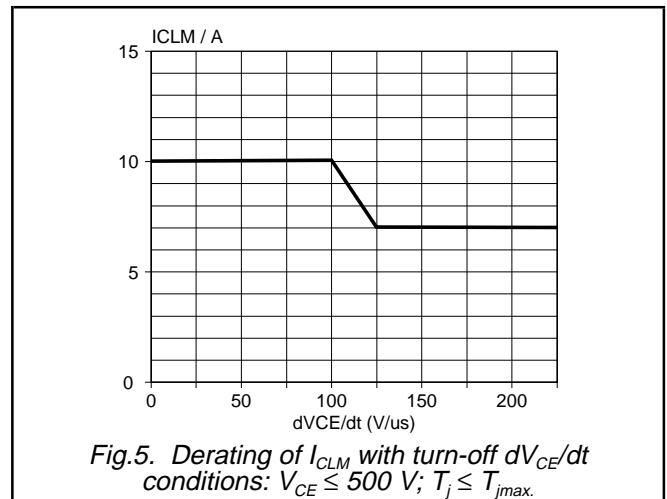
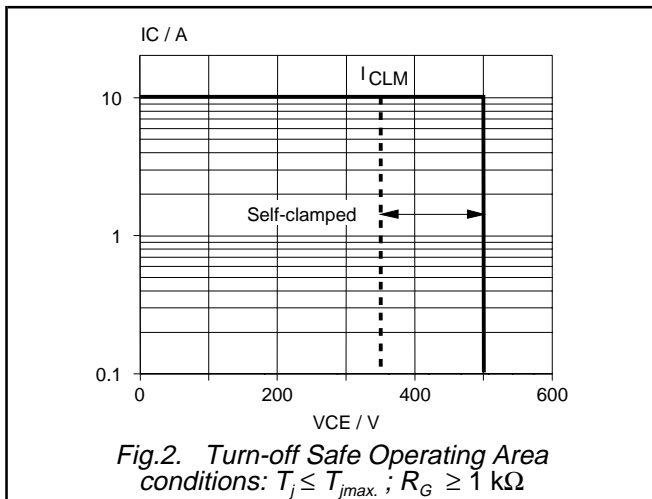
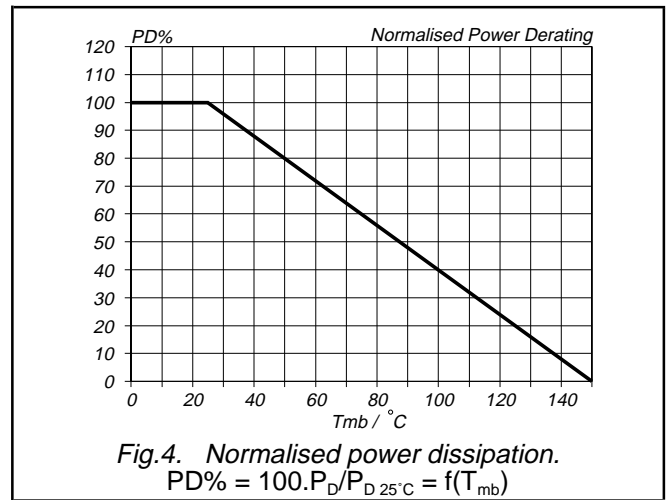
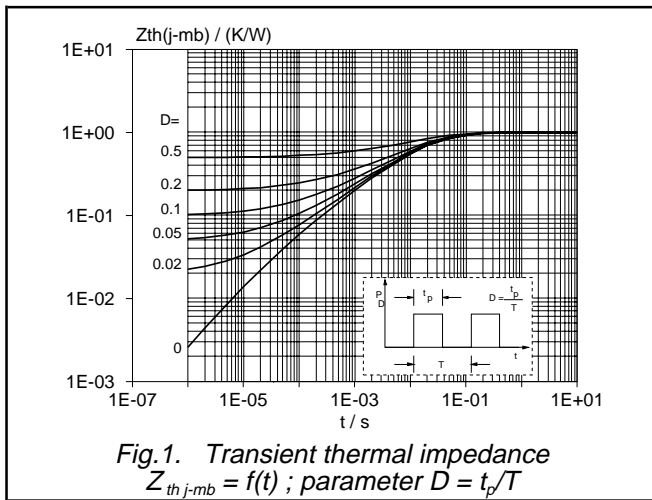

Insulated Gate Bipolar Transistor
Protected Logic-Level IGBT

BUK866-400 IZ

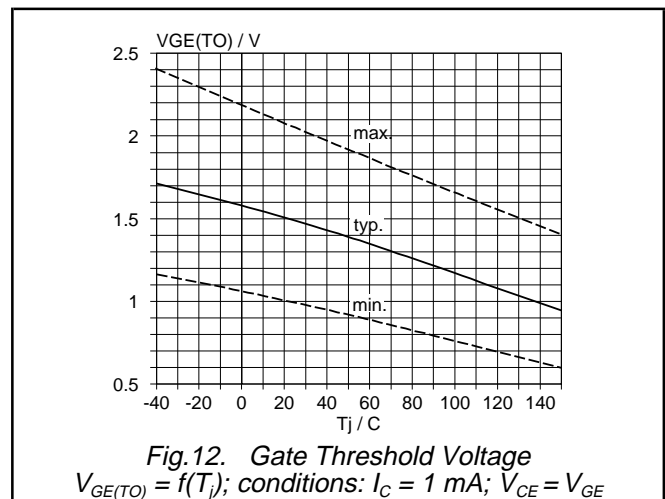
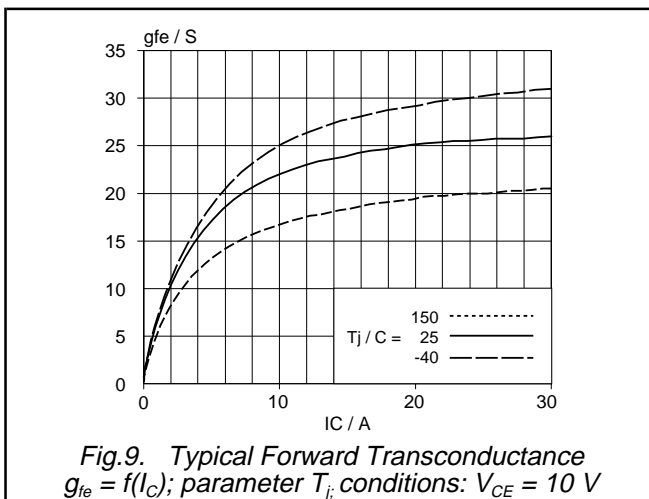
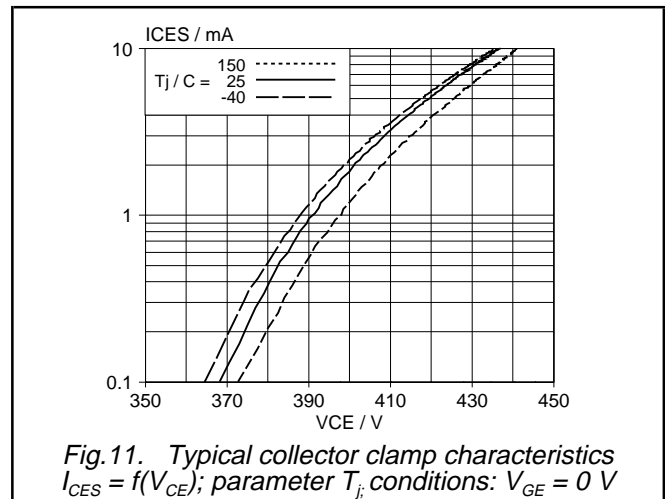
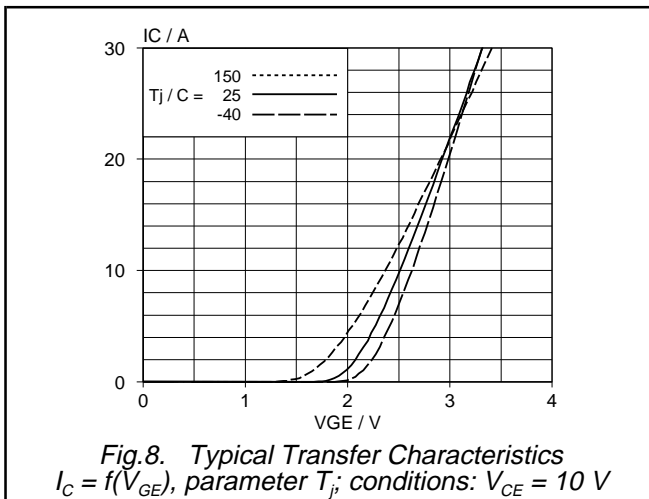
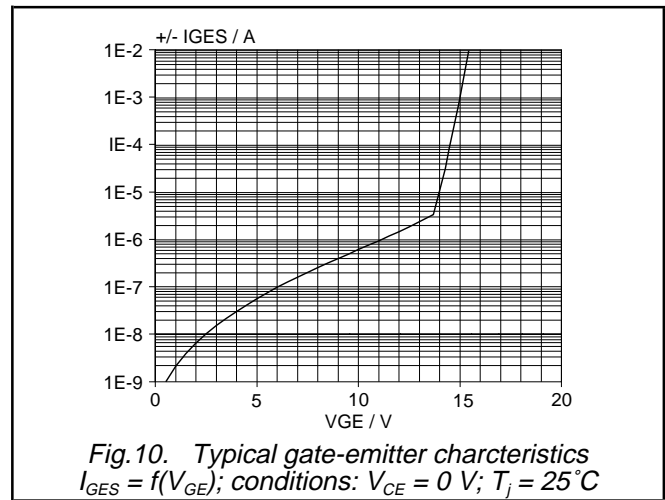
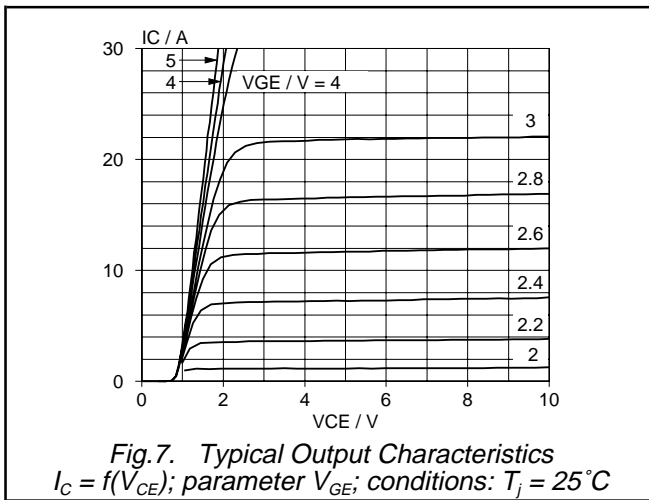

Insulated Gate Bipolar Transistor
Protected Logic-Level IGBT

BUK866-400 IZ

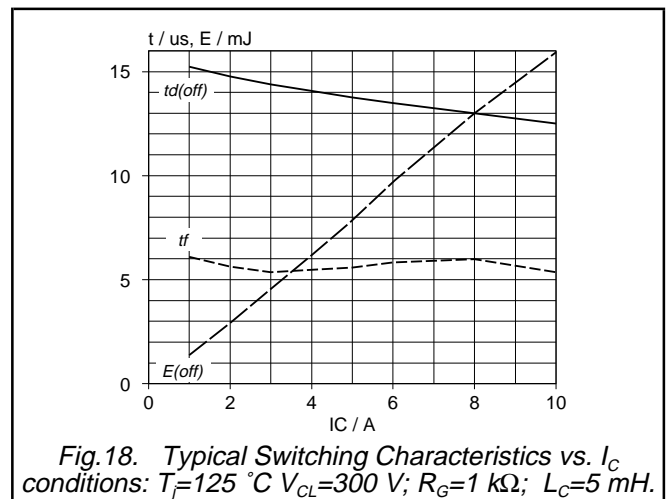
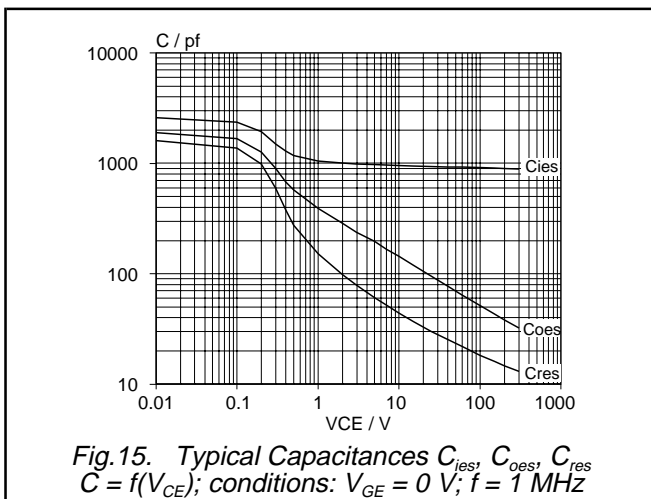
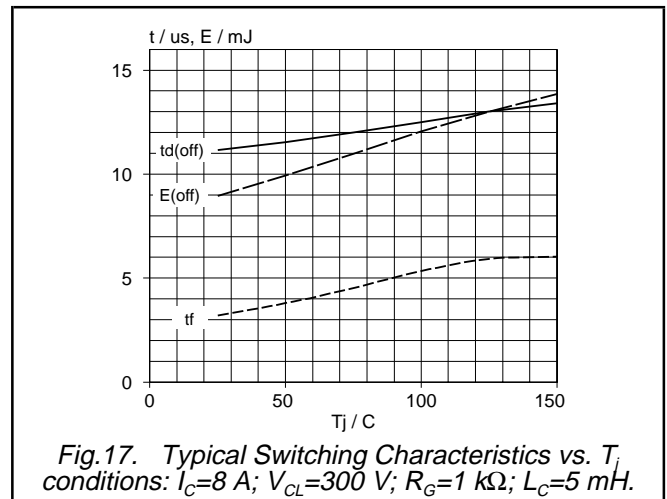
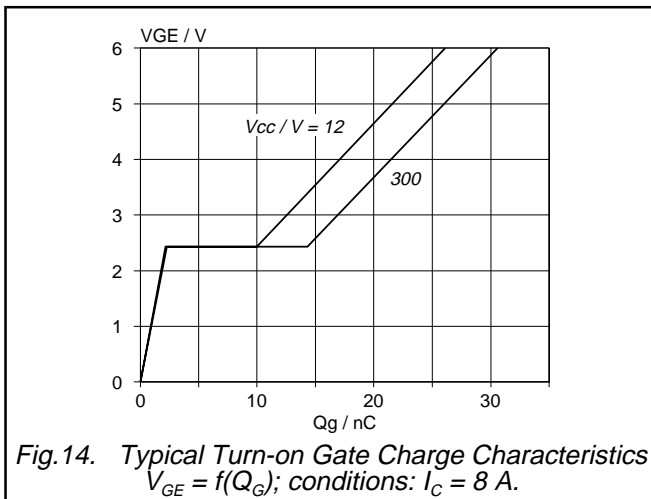
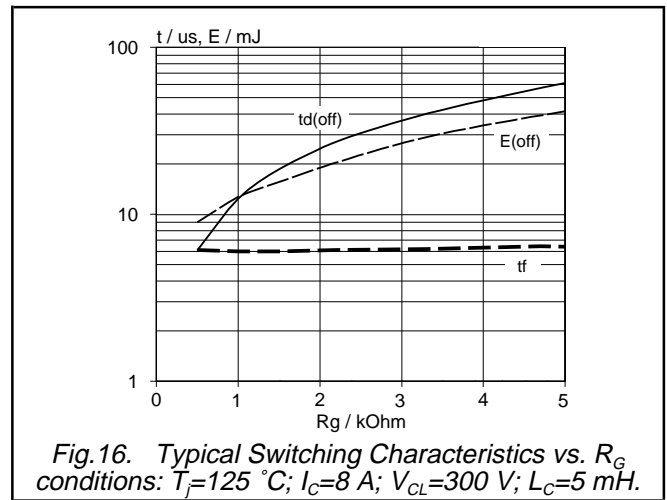
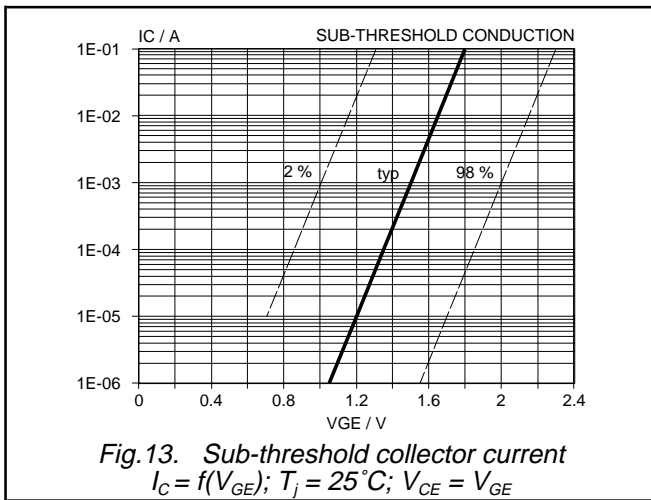

Insulated Gate Bipolar Transistor Protected Logic-Level IGBT

BUK866-400 IZ

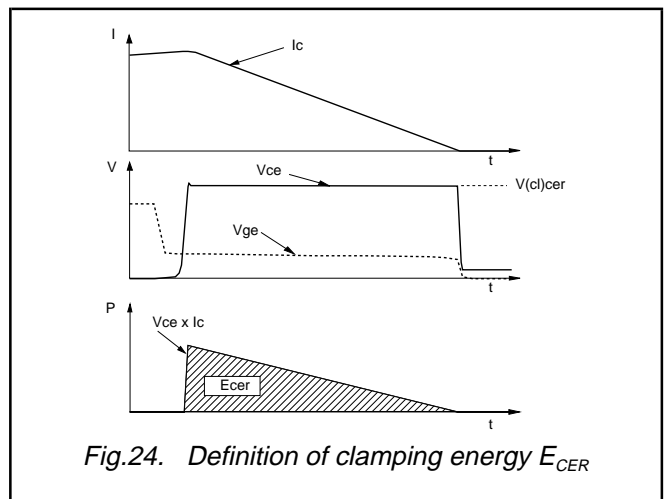
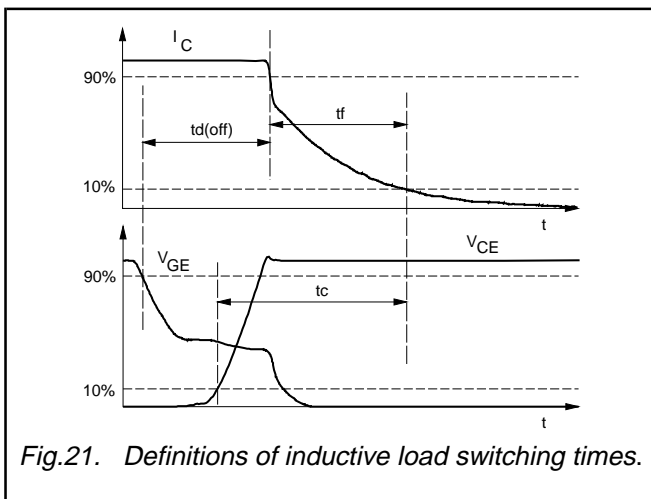
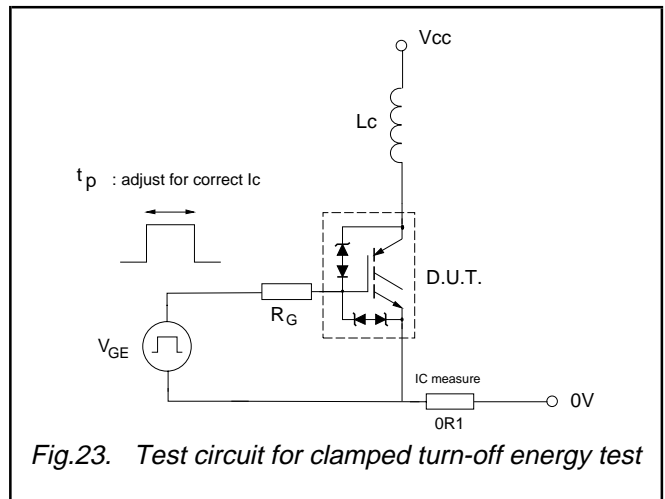
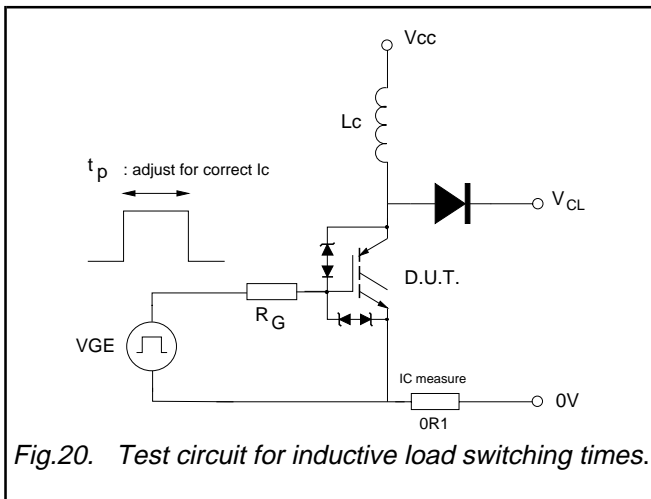
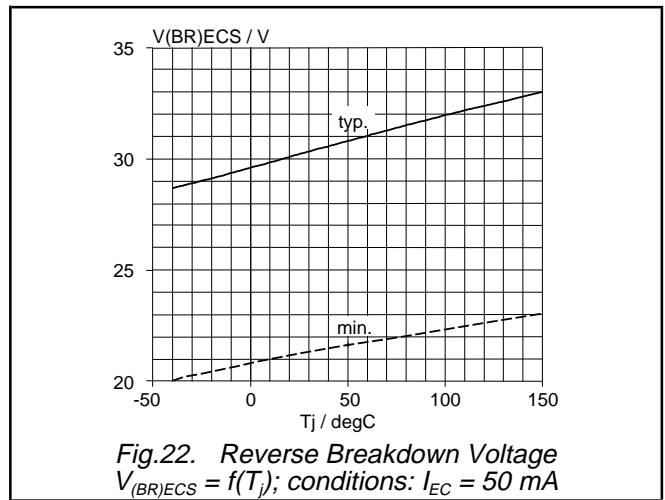
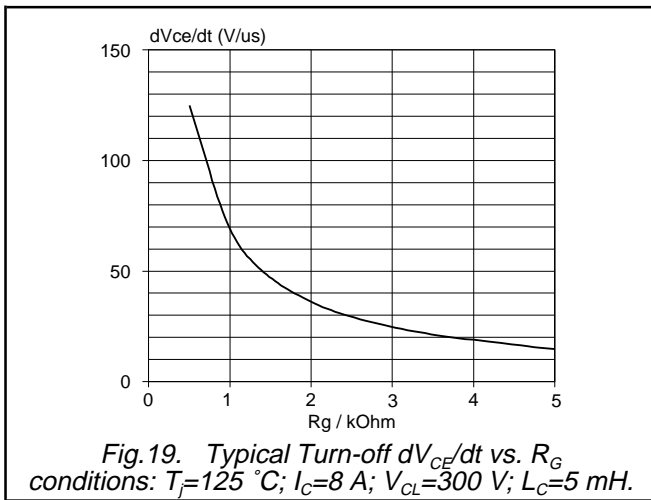

Insulated Gate Bipolar Transistor
Protected Logic-Level IGBT

BUK866-400 IZ

MECHANICAL DATA

Dimensions in mm

Net Mass: 1.4 g

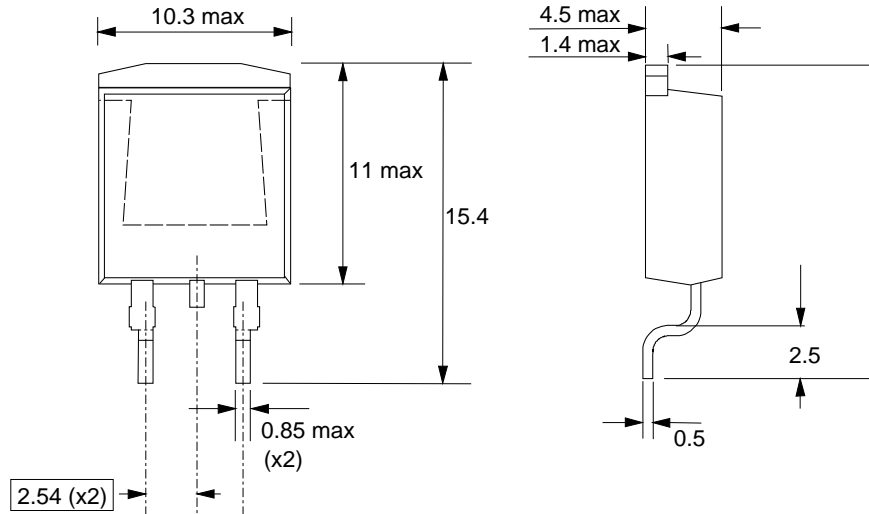

Fig.25. SOT404 : centre pin connected to mounting base.

MOUNTING INSTRUCTIONS

Dimensions in mm

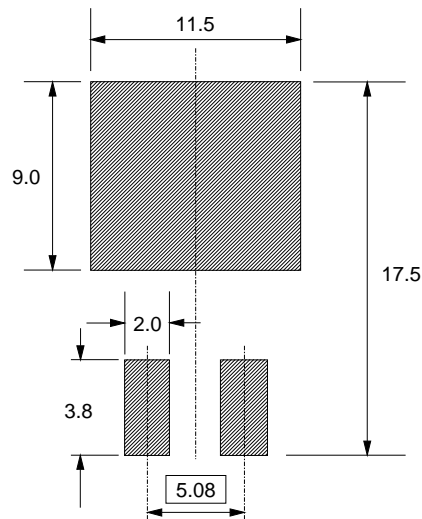

Fig.26. SOT404 : soldering pattern for surface mounting.

Notes

1. Observe the general handling precautions for electrostatic-discharge sensitive devices (ESDs) to prevent damage to MOS gate oxide.
2. Epoxy meets UL94 V0 at 1/8".

Insulated Gate Bipolar Transistor Protected Logic-Level IGBT

BUK866-400 IZ

DEFINITIONS

Data sheet status	
Objective specification	This data sheet contains target or goal specifications for product development.
Preliminary specification	This data sheet contains preliminary data; supplementary data may be published later.
Product specification	This data sheet contains final product specifications.
Limiting values	
Limiting values are given in accordance with the Absolute Maximum Rating System (IEC 134). Stress above one or more of the limiting values may cause permanent damage to the device. These are stress ratings only and operation of the device at these or at any other conditions above those given in the Characteristics sections of this specification is not implied. Exposure to limiting values for extended periods may affect device reliability.	
Application information	
Where application information is given, it is advisory and does not form part of the specification.	
© Philips Electronics N.V. 1996	
All rights are reserved. Reproduction in whole or in part is prohibited without the prior written consent of the copyright owner.	
The information presented in this document does not form part of any quotation or contract, it is believed to be accurate and reliable and may be changed without notice. No liability will be accepted by the publisher for any consequence of its use. Publication thereof does not convey nor imply any license under patent or other industrial or intellectual property rights.	

LIFE SUPPORT APPLICATIONS

These products are not designed for use in life support appliances, devices or systems where malfunction of these products can be reasonably expected to result in personal injury. Philips customers using or selling these products for use in such applications do so at their own risk and agree to fully indemnify Philips for any damages resulting from such improper use or sale.