

**TOPFET high side switch
SMD version of BUK200-50Y**

BUK204-50Y

DESCRIPTION

Monolithic temperature and overload protected power switch based on MOSFET technology in a 5 pin plastic surface mount envelope, configured as a single high side switch.

APPLICATIONS

General controller for driving lamps, motors, solenoids, heaters.

QUICK REFERENCE DATA

SYMBOL	PARAMETER	MIN.	UNIT
I_L	Nominal load current (ISO)	3.5	A
SYMBOL	PARAMETER	MAX.	UNIT
V_{BG}	Continuous off-state supply voltage	50	V
I_L	Continuous load current	10	A
T_j	Continuous junction temperature	150	°C
R_{ON}	On-state resistance	100	mΩ

FEATURES

- Vertical power DMOS switch
- Low on-state resistance
- 5 V logic compatible input
- Overtemperature protection - self resets with hysteresis
- Overload protection against short circuit load with output current limiting; latched - reset by input
- High supply voltage load protection
- Supply undervoltage lock out
- Status indication for overload protection activated
- Diagnostic status indication of open circuit load
- Very low quiescent current
- Voltage clamping for turn off of inductive loads
- ESD protection on all pins
- Reverse battery and overvoltage protection

FUNCTIONAL BLOCK DIAGRAM

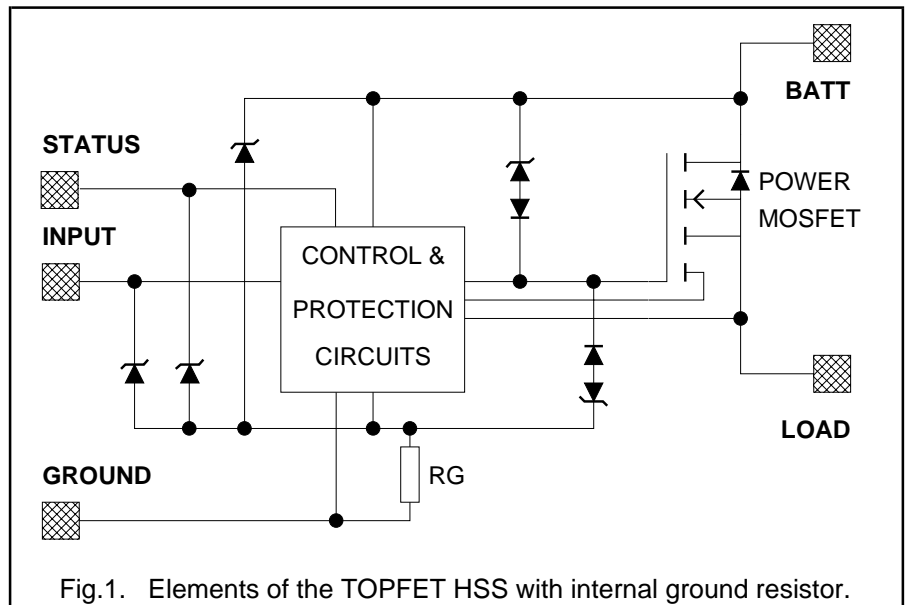

PINNING - SOT426

PIN	DESCRIPTION
1	Ground
2	Input
3	(connected to mb)
4	Status
5	Load
mb	Battery

PIN CONFIGURATION

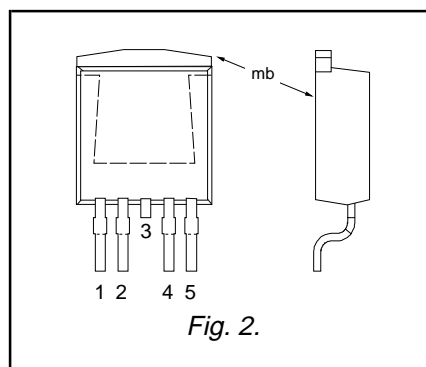

SYMBOL

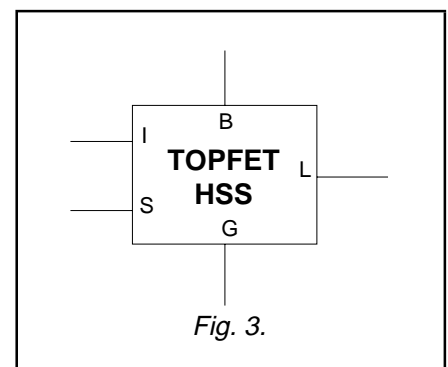

TOPFET high side switch
SMD version of BUK200-50Y

BUK204-50Y

LIMITING VALUES

Limiting values in accordance with the Absolute Maximum System (IEC 134)

SYMBOL	PARAMETER	CONDITIONS	MIN.	MAX.	UNIT
V_{BG}	Battery voltages Continuous off-state supply voltage	-	0	50	V
$-V_{BG}$	Reverse battery voltages¹ Repetitive peak supply voltage	External resistors: $R_I = R_S \geq 4.7 \text{ k}\Omega$, $\delta \leq 0.1$	-	32	V
$-V_{BG}$	Continuous reverse supply voltage	$R_I = R_S \geq 4.7 \text{ k}\Omega$	-	16	V
I_L	Continuous load current	$T_{mb} \leq 115 \text{ }^\circ\text{C}$	-	10	A
P_D	Total power dissipation	$T_{mb} \leq 25 \text{ }^\circ\text{C}$	-	62.5	W
T_{stg}	Storage temperature	-	-55	175	$^\circ\text{C}$
T_j	Continuous junction temperature ²	-	-	150	$^\circ\text{C}$
T_{sold}	Lead temperature	during soldering	-	250	$^\circ\text{C}$
	Input and status				
I_I	Continuous input current	-	-5	5	mA
I_S	Continuous status current	-	-5	5	mA
I_I	Repetitive peak input current	$\delta \leq 0.1$	-20	20	mA
I_S	Repetitive peak status current	$\delta \leq 0.1$	-20	20	mA
	Inductive load clamping				
E_{BL}	Non-repetitive clamping energy	$T_{mb} = 150 \text{ }^\circ\text{C}$ prior to turn-off	-	1.2	J

ESD LIMITING VALUE

SYMBOL	PARAMETER	CONDITIONS	MIN.	MAX.	UNIT
V_C	Electrostatic discharge capacitor voltage	Human body model; $C = 250 \text{ pF}$; $R = 1.5 \text{ k}\Omega$	-	2	kV

THERMAL CHARACTERISTIC

SYMBOL	PARAMETER	CONDITIONS	MIN.	TYP.	MAX.	UNIT
$R_{th \text{ j-mb}}$	Thermal resistance³ Junction to mounting base	-	-	1.5	2	K/W

¹ Reverse battery voltage is allowed only with external input and status resistors to limit the currents to a safe value.

² For normal continuous operation. A higher T_j is allowed as an overload condition but at the threshold $T_{j(TO)}$ the over temperature trip operates to protect the switch.

³ Of the output Power MOS transistor.

TOPFET high side switch
SMD version of BUK200-50Y

BUK204-50Y

STATIC CHARACTERISTICS
 $T_{mb} = 25\text{ °C}$ unless otherwise stated

SYMBOL	PARAMETER	CONDITIONS	MIN.	TYP.	MAX.	UNIT
Clamping voltages						
V_{BG}	Battery to ground	$I_G = 1\text{ mA}$	50	55	65	V
V_{BL}	Battery to load	$I_L = I_G = 1\text{ mA}$	50	55	65	V
$-V_{LG}$	Negative load to ground	$I_L = 1\text{ mA}$	12	17	21	V
Supply voltage						
V_{BG}	Operating range ¹	battery to ground -	5	-	40	V
Currents						
I_L	Nominal load current ²	$V_{BG} = 13\text{ V}$ $V_{BL} = 0.5\text{ V}$; $T_{mb} = 85\text{ °C}$	3.5	-	-	A
I_B	Quiescent current ³	$V_{IG} = 0\text{ V}$; $V_{LG} = 0\text{ V}$	-	0.1	2	μA
I_G	Operating current ⁴	$V_{IG} = 5\text{ V}$; $I_L = 0\text{ A}$	1.5	2.2	4	mA
I_L	Off-state load current ⁵	$V_{BL} = 13\text{ V}$; $V_{IG} = 0\text{ V}$	-	0.1	1	μA
Resistances						
R_{ON}	On-state resistance ⁶	$V_{BG} = 13\text{ V}$; $I_L = 5\text{ A}$; $t_p = 300\text{ }\mu\text{s}$	-	77	100	m Ω
R_{ON}	On-state resistance	$V_{BG} = 5\text{ V}$; $I_L = 1\text{ A}$; $t_p = 300\text{ }\mu\text{s}$	-	116	150	m Ω
R_G	Internal ground resistance	$I_G = 10\text{ mA}$	-	150	-	Ω

INPUT CHARACTERISTICS
 $T_{mb} = 25\text{ °C}$; $V_{BG} = 13\text{ V}$

SYMBOL	PARAMETER	CONDITIONS	MIN.	TYP.	MAX.	UNIT
I_i	Input current	$V_{IG} = 5\text{ V}$	35	60	100	μA
V_{IG}	Input clamping voltage	$I_i = 200\text{ }\mu\text{A}$	6	7.5	8.5	V
$V_{IG(ON)}$	Input turn-on threshold voltage		-	2.1	2.7	V
$V_{IG(OFF)}$	Input turn-off threshold voltage		1.5	2	-	V

¹ On-state resistance is increased if the supply voltage is less than 9 V. Refer to figure 8.

² Defined as in ISO 10483-1.

³ This is the continuous current drawn from the battery when the input is low and includes leakage current to the load.

⁴ This is the continuous current drawn from the battery with no load connected, but with the input high.

⁵ The measured current is in the load pin only.

⁶ The supply and input voltage for the R_{ON} tests are continuous. The specified pulse duration t_p refers only to the applied load current.

TOPFET high side switch

SMD version of BUK200-50Y

BUK204-50Y

PROTECTION FUNCTIONS AND STATUS INDICATIONS

Truth table for normal, open-circuit load and overload conditions and abnormal supply voltages.

FUNCTIONS		TRUTH TABLE			THRESHOLD			
SYMBOL	CONDITION	INPUT	STATUS	OUTPUT	MIN.	TYP.	MAX.	UNIT
	Normal on-state	1	1	1				
	Normal off-state	0	1	0				
$I_{L(OC)}$	Open circuit load ¹	1	0	1	50	200	350	mA
	Open circuit load	0	1	0				
$T_{J(TO)}$	Over temperature ²	1	0	0	150	175	-	°C
	Over temperature ³	0	0	0				
$V_{BL(TO)}$	Short circuit load ⁴	1	0	0	8.5	10.3	12	V
	Short circuit load	0	1	0				
$V_{BG(TO)}$	Low supply voltage ⁵	X	1	0	3	4	5	V
$V_{BG(LP)}$	High supply voltage ⁶	X	1	0	40	45	50	V

For input '0' equals low, '1' equals high, 'X' equals don't care.
 For status '0' equals low, '1' equals open or high.
 For output switch '0' equals off, '1' equals on.

STATUS CHARACTERISTICS

$T_{mb} = 25\text{ °C}$.

The status output is an open drain transistor, and requires an external pull-up circuit to indicate a logic high.

SYMBOL	PARAMETER	CONDITIONS	MIN.	TYP.	MAX.	UNIT
V_{SG}	Status clamping voltage	$I_S = 100\ \mu\text{A}$; $V_{IG} = 0\ \text{V}$	6	7	8	V
V_{SG}	Status low voltage	$I_S = 50\ \mu\text{A}$; $V_{BG} = 13\ \text{V}$; $V_{IG} = 5\ \text{V}$	-	0.7	0.8	V
I_S	Status leakage current	$V_{SG} = 5\ \text{V}$	-	0.1	1	μA
I_S	Status saturation current ⁷	$V_{SS} = 5\ \text{V}$; $R_S = 0\ \Omega$; $V_{BG} = 13\ \text{V}$	-	5	-	mA
R_S	Application information External pull-up resistor ⁸	$V_{SS} = 5\ \text{V}$	-	100	-	k Ω

1 In the on-state, the switch detects whether the load current is less than the quoted open load threshold current. This is for status indication only. Typical hysteresis equals 80 mA. The thresholds are specified for supply voltage within the normal working range.

2 After cooling below the reset temperature the switch will resume normal operation. The reset temperature is lower than the trip temperature by typically 10 °C.

3 If the overtemperature protection has operated, status remains low to indicate the overtemperature condition even if the input is taken low, providing the device has not cooled below the reset temperature.

4 After short circuit protection has operated, the input voltage must be toggled low for the switch to resume normal operation.

5 Undervoltage sensor causes the device to switch off. Typical hysteresis equals 0.7 V.

6 Overvoltage sensor causes the device to switch off to protect the load. Typical hysteresis equals 1.3 V.

7 In a fault condition with the pull-up resistor short circuited while the status transistor is conducting.

8 The pull-up resistor also protects the status pin during reverse battery conditions.

TOPFET high side switch

SMD version of BUK200-50Y

BUK204-50Y

DYNAMIC CHARACTERISTICS

 $T_{mb} = 25\text{ }^{\circ}\text{C}; V_{BG} = 13\text{ V}$

SYMBOL	PARAMETER	CONDITIONS	MIN.	TYP.	MAX.	UNIT
$-V_{LG}$	Inductive load turn-off Negative load voltage ¹	$V_{IG} = 0\text{ V}; I_L = 5\text{ A}; t_p = 300\text{ }\mu\text{s}$	15	20	25	V
$t_{d\text{ sc}}$	Short circuit load protection² Response time	$V_{IG} = 5\text{ V}; R_L \leq 10\text{ m}\Omega$	-	90	-	μs
I_L	Load current prior to turn-off	$t < t_{d\text{ sc}}$	-	35	-	A
$I_{L(\text{lim})}$	Overload protection³ Load current limiting	$V_{BL} = 8.5\text{ V}; t_p = 300\text{ }\mu\text{s}$	23	33	43	A

SWITCHING CHARACTERISTICS

 $T_{mb} = 25\text{ }^{\circ}\text{C}, V_{BG} = 13\text{ V}, \text{ for resistive load } R_L = 13\text{ }\Omega.$

SYMBOL	PARAMETER	CONDITIONS	MIN.	TYP.	MAX.	UNIT
$t_{d\text{ on}}$	During turn-on Delay time	to $V_{IG} = 5\text{ V}$ to 10% V_L	-	16	-	μs
$dV/dt_{\text{ on}}$	Rate of rise of load voltage		-	1	2.5	V/ μs
$t_{\text{ on}}$	Total switching time	to 90% V_L	-	40	-	μs
$t_{d\text{ off}}$	During turn-off Delay time	to $V_{IG} = 0\text{ V}$ to 90% V_L	-	30	-	μs
$dV/dt_{\text{ off}}$	Rate of fall of load voltage		-	1.2	2.5	V/ μs
$t_{\text{ off}}$	Total switching time	to 10% V_L	-	50	-	μs

CAPACITANCES

 $T_{mb} = 25\text{ }^{\circ}\text{C}; f = 1\text{ MHz}; V_{IG} = 0\text{ V}$

SYMBOL	PARAMETER	CONDITIONS	MIN.	TYP.	MAX.	UNIT
C_{ig}	Input capacitance	$V_{BG} = 13\text{ V}$	-	15	20	pF
C_{bl}	Output capacitance	$V_{BL} = V_{BG} = 13\text{ V}$	-	330	460	pF
C_{sg}	Status capacitance	$V_{SG} = 5\text{ V}$	-	11	15	pF

1 For a high side switch, the load pin voltage goes negative with respect to ground during the turn-off of an inductive load. This negative voltage is clamped by the device.

2 The load current is self-limited during the response time for short circuit load protection. Response time is measured from when input goes high.

3 If the load resistance is low, but not a complete short circuit, such that the on-state voltage remains less than $V_{BL(TO)}$, the device remains in current limiting until the overtemperature protection operates.

TOPFET high side switch
SMD version of BUK200-50Y

BUK204-50Y

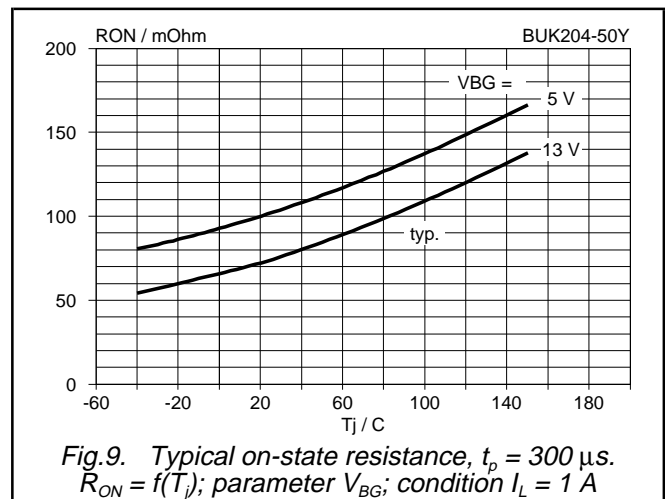
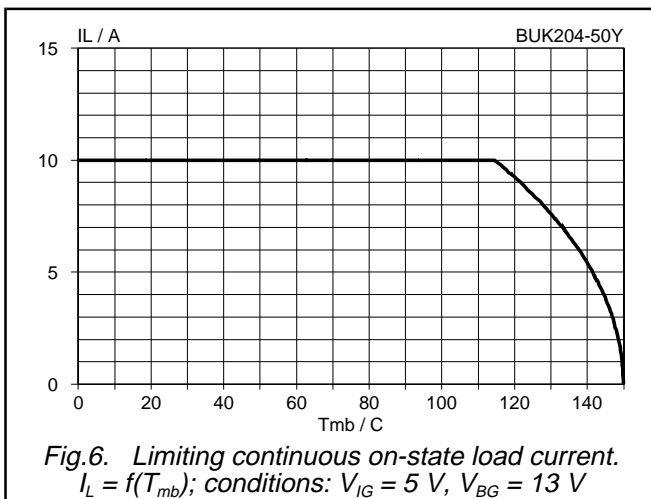
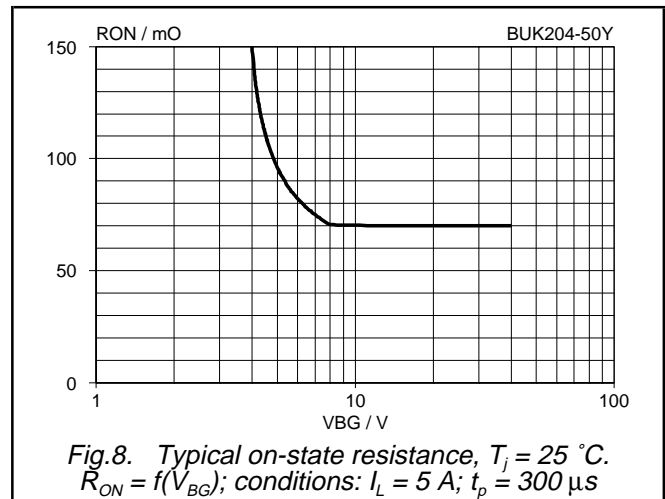
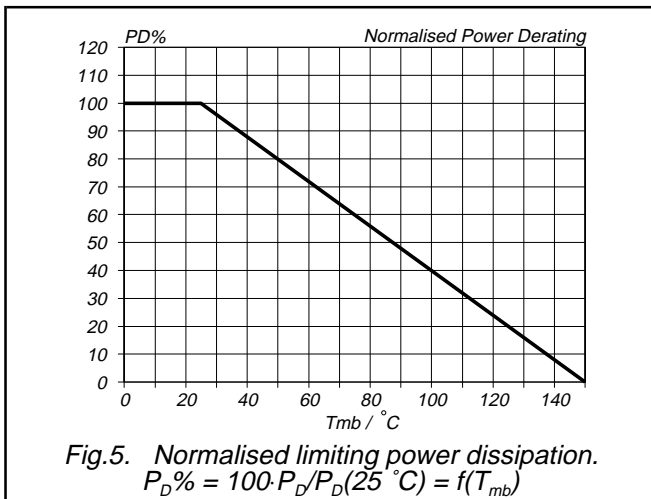
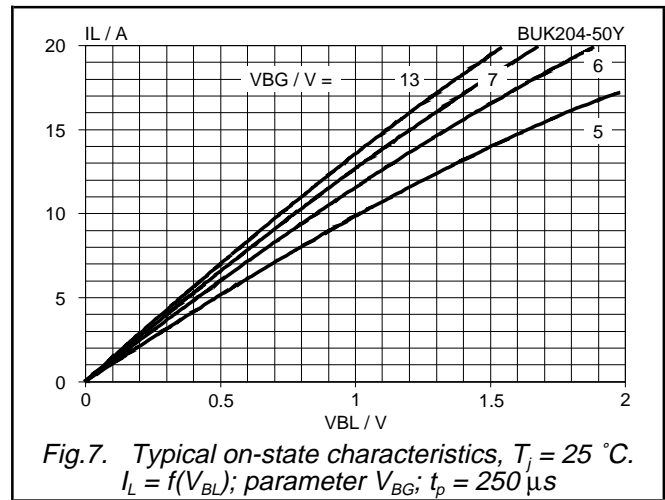
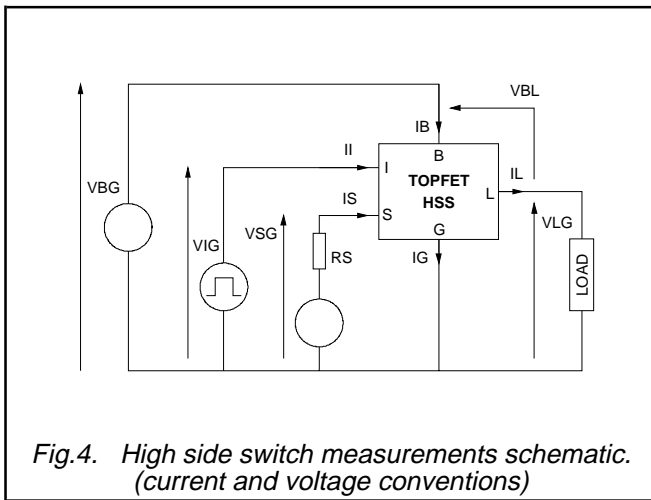

TOPFET high side switch
SMD version of BUK200-50Y

BUK204-50Y

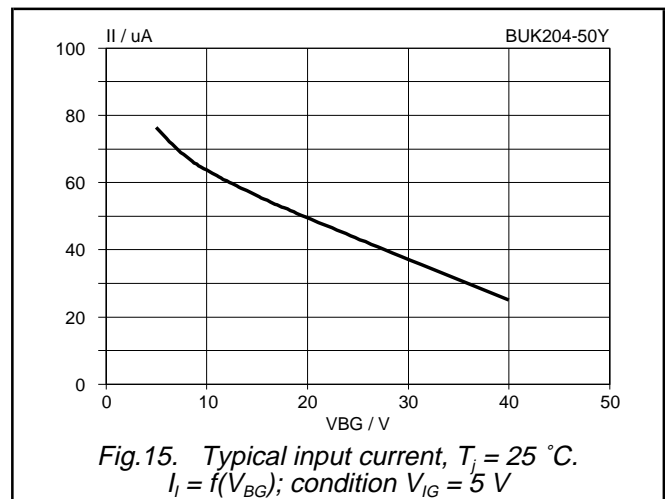
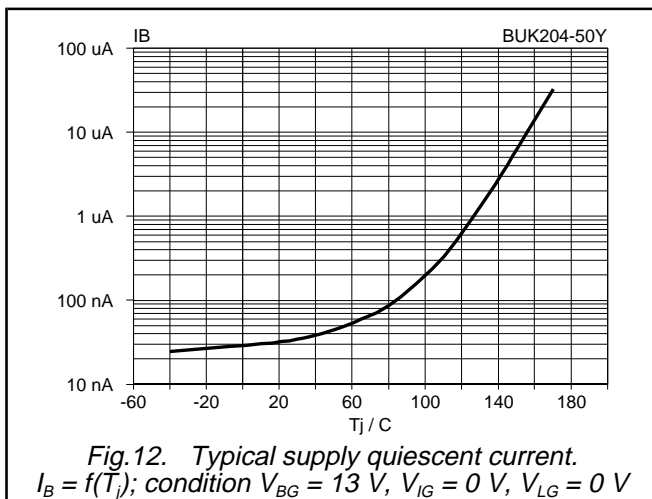
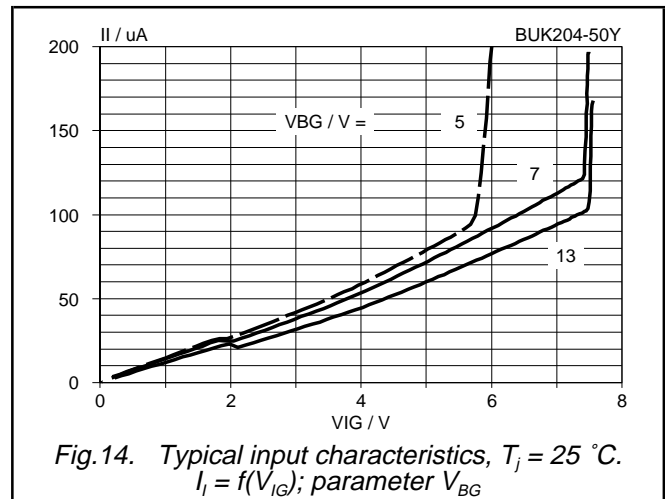
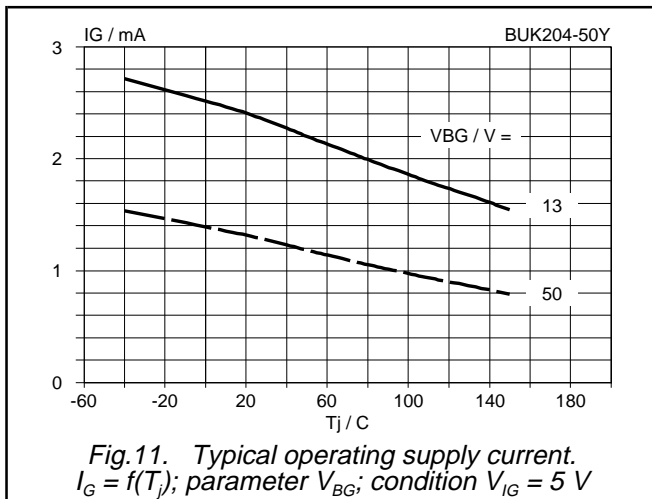
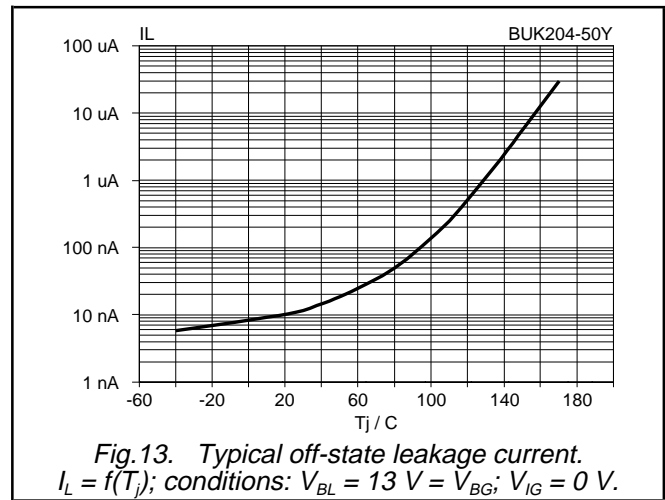
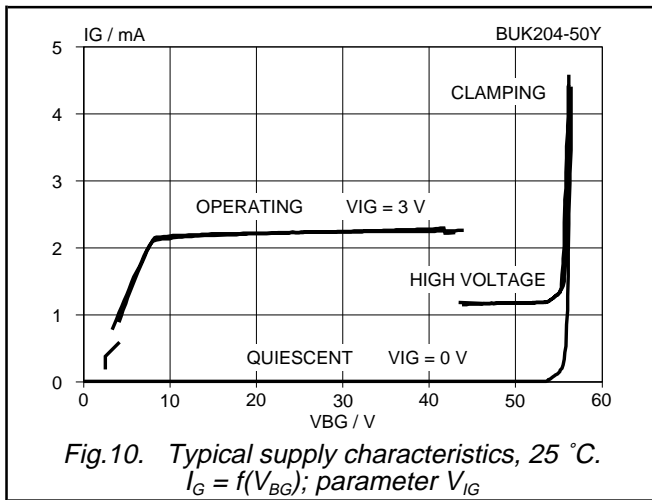

TOPFET high side switch
SMD version of BUK200-50Y

BUK204-50Y

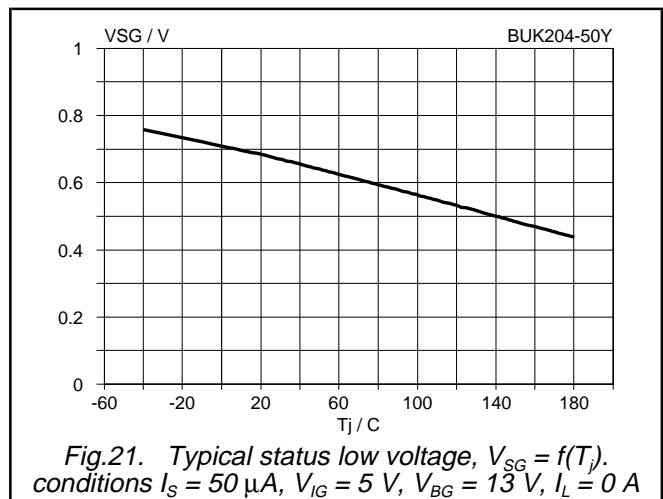
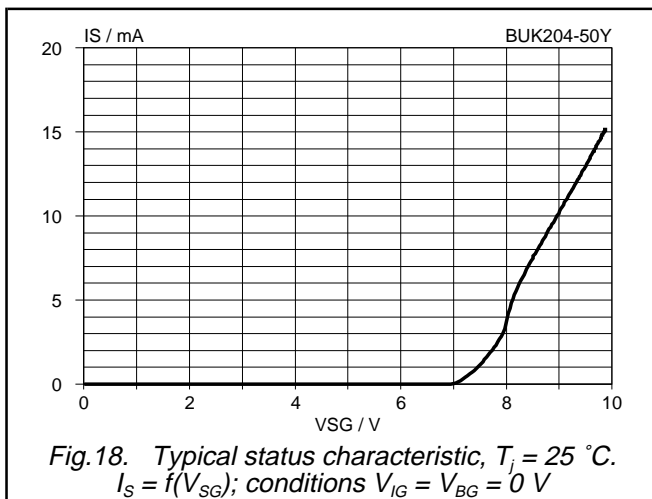
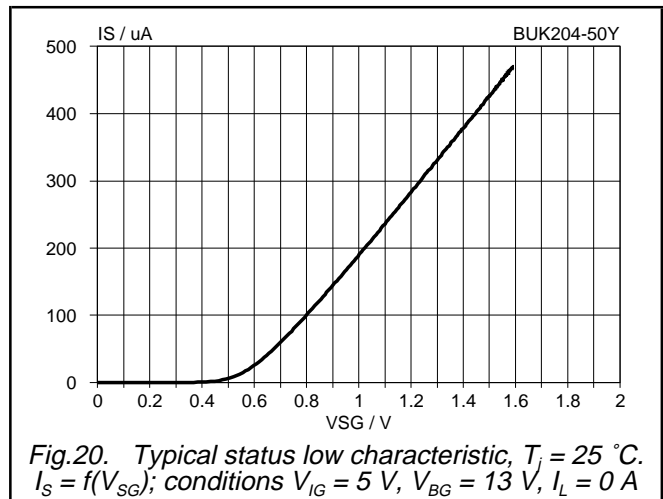
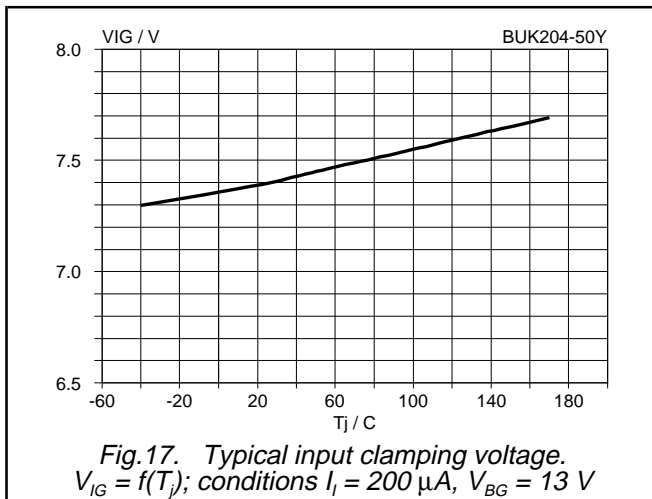
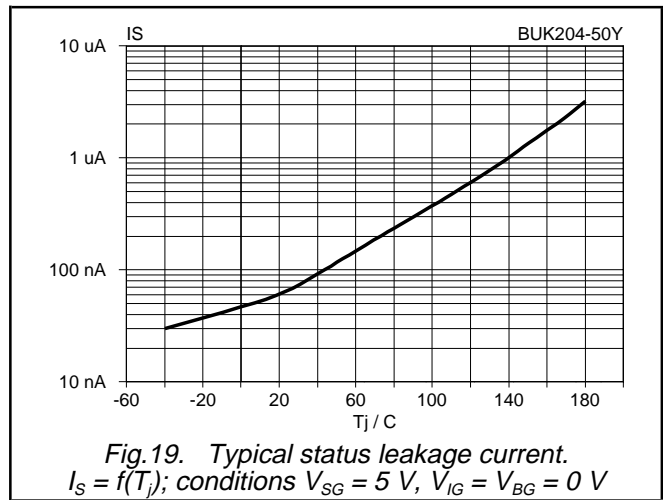
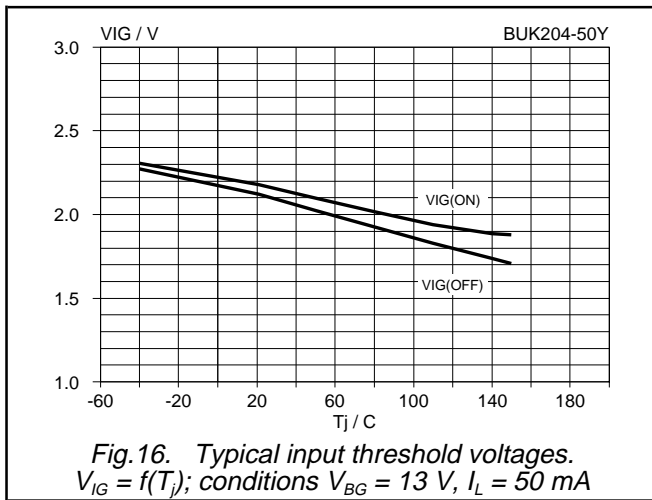

TOPFET high side switch
SMD version of BUK200-50Y

BUK204-50Y

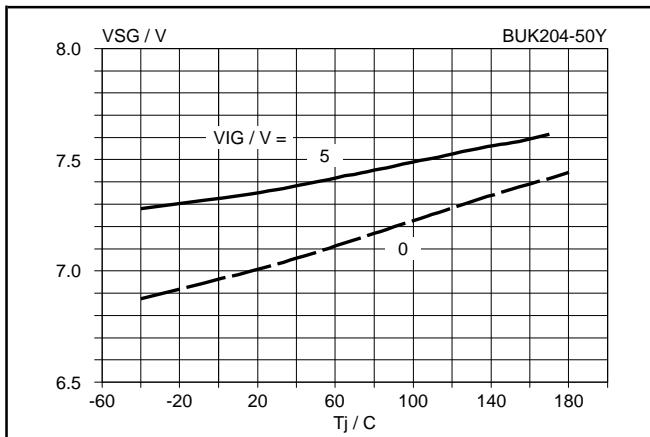

Fig.22. Typical status clamping voltage, $V_{SG} = f(T_j)$. parameter V_{IG} ; conditions $I_S = 100 \mu A$, $V_{BG} = 13 V$

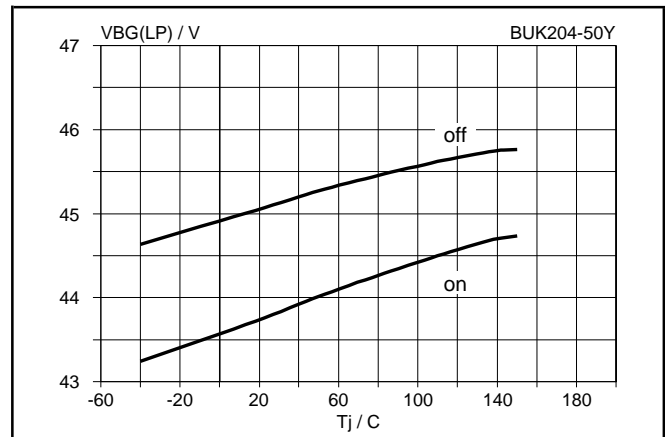

Fig.25. Supply typical overvoltage thresholds. $V_{BG(LP)} = f(T_j)$; conditions $V_{IG} = 5 V$; $I_L = 50 mA$

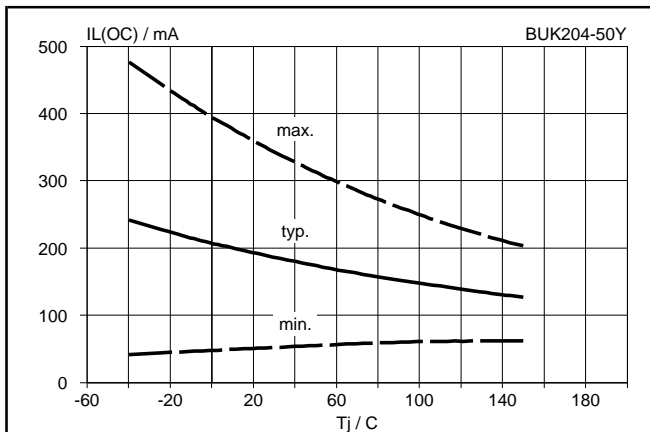

Fig.23. Low load current detection threshold. $I_{L(OC)} = f(T_j)$; conditions $V_{IG} = 5 V$; $V_{BG} = 13 V$

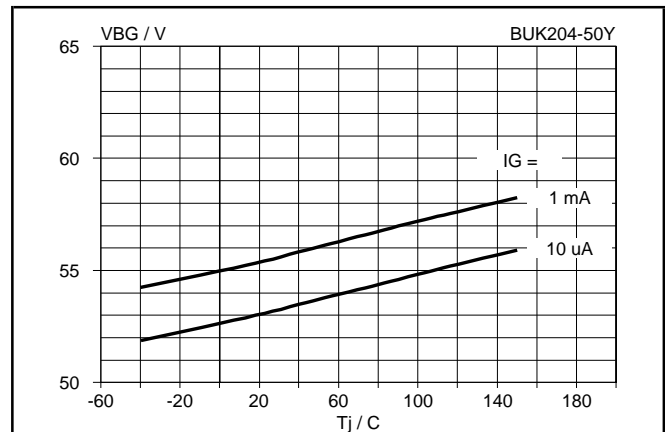

Fig.26. Typical battery to ground clamping voltage. $V_{BG} = f(T_j)$; parameter I_G

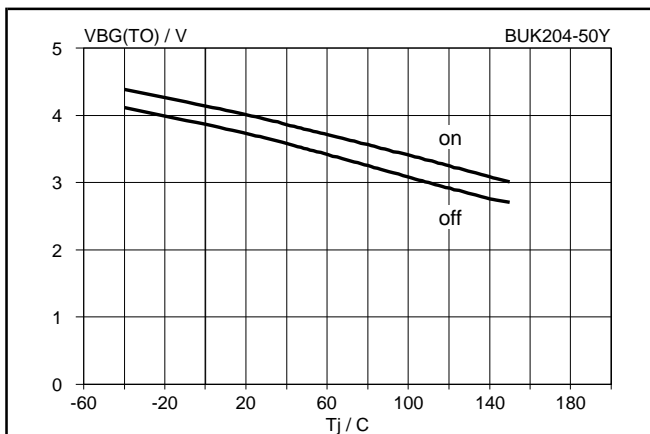

Fig.24. Supply typical undervoltage thresholds. $V_{BG(TO)} = f(T_j)$; conditions $V_{IG} = 3 V$; $I_L = 50 mA$

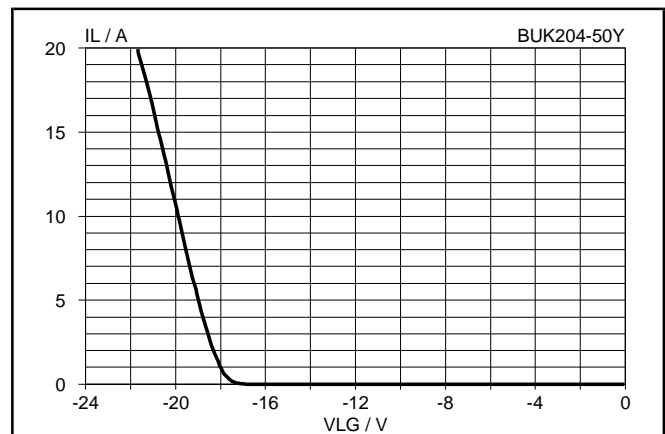
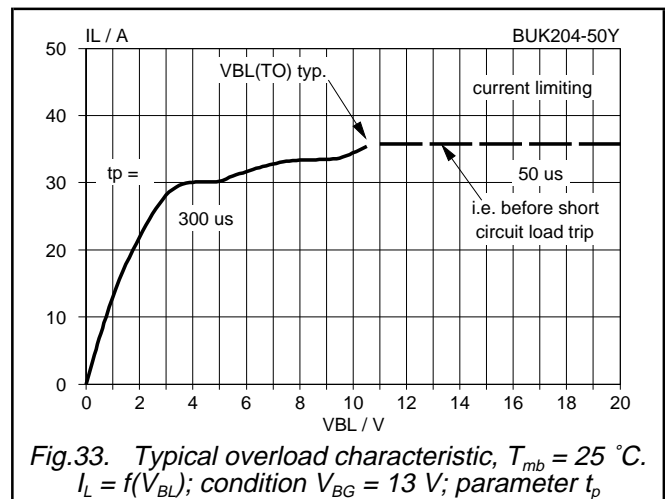
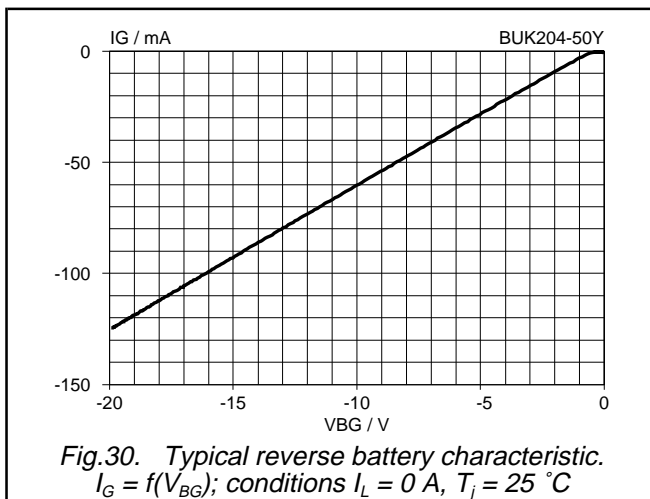
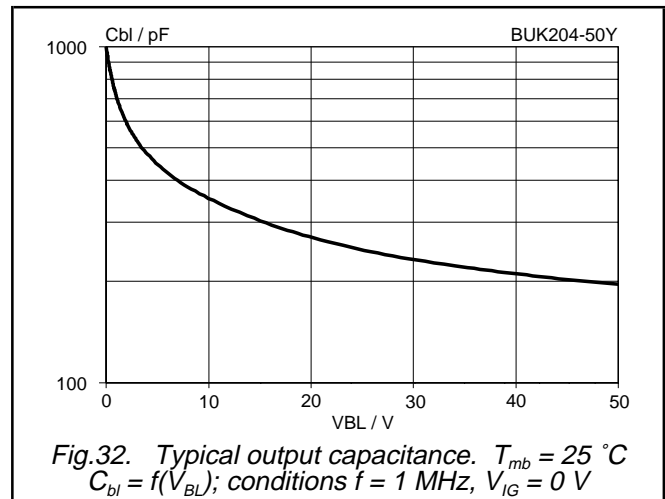
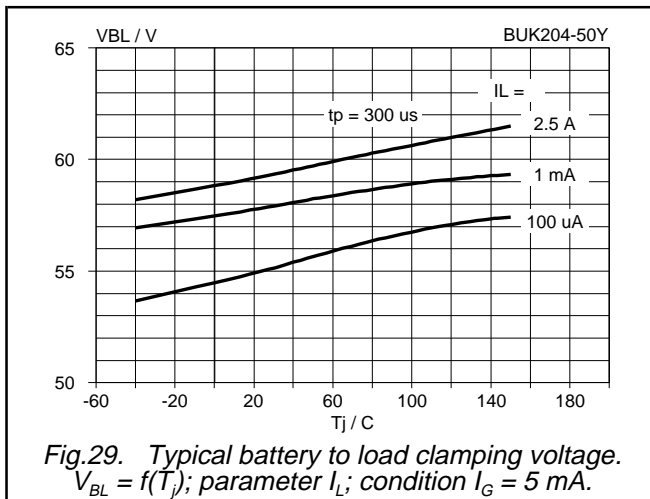
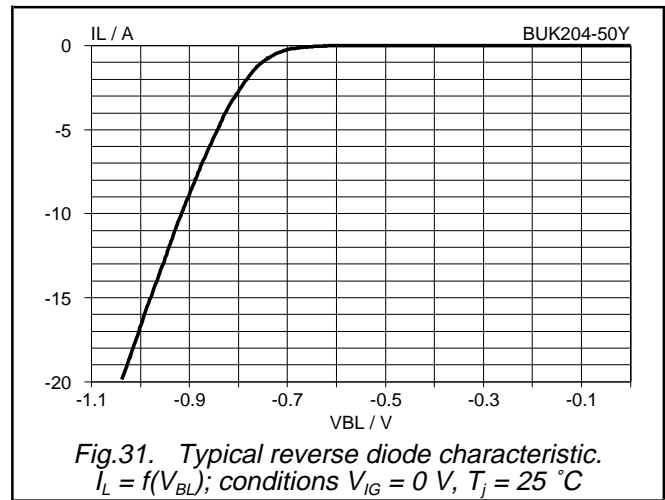
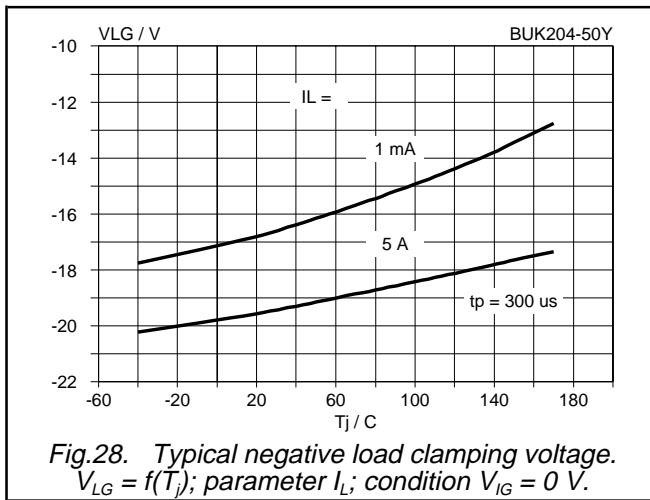

Fig.27. Typical negative load clamping characteristic. $I_L = f(V_{LG})$; conditions $V_{IG} = 0 V$, $t_p = 300 \mu s$, $25^\circ C$

TOPFET high side switch
SMD version of BUK200-50Y

BUK204-50Y



TOPFET high side switch
SMD version of BUK200-50Y

BUK204-50Y

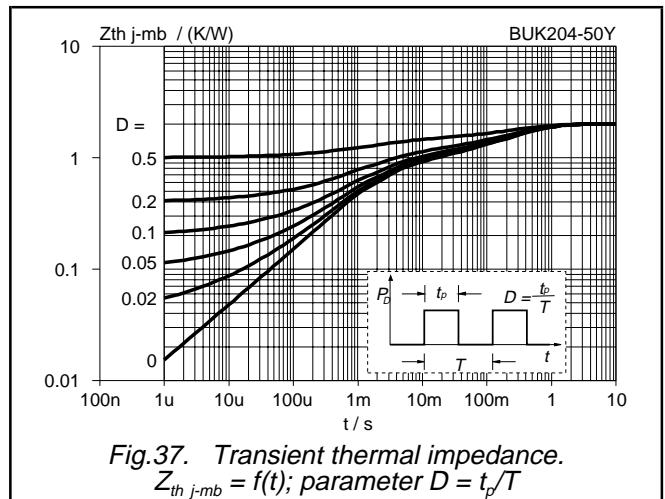
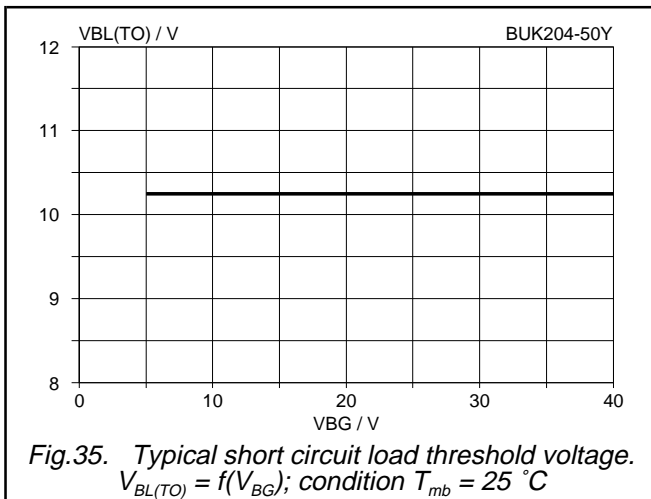
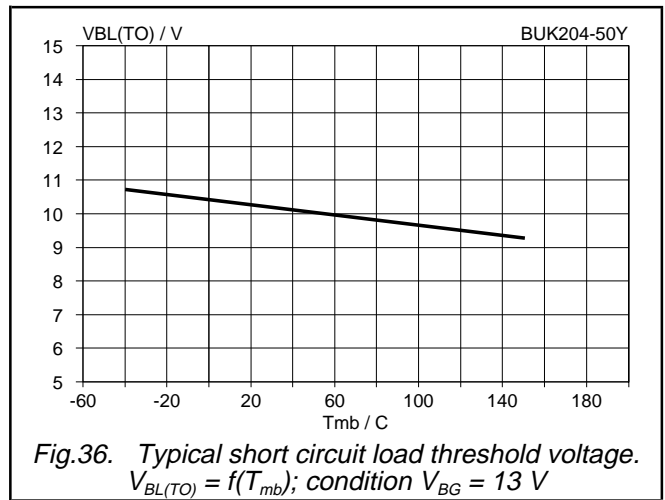
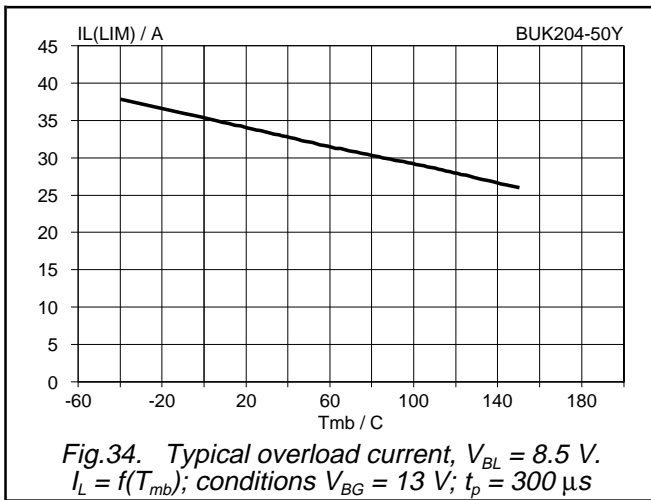

TOPFET high side switch
SMD version of BUK200-50Y

BUK204-50Y

MECHANICAL DATA



MOUNTING INSTRUCTIONS



TOPFET high side switch
SMD version of BUK200-50Y

BUK204-50Y

DEFINITIONS

Data sheet status	
Objective specification	This data sheet contains target or goal specifications for product development.
Preliminary specification	This data sheet contains preliminary data; supplementary data may be published later.
Product specification	This data sheet contains final product specifications.
Limiting values	
Limiting values are given in accordance with the Absolute Maximum Rating System (IEC 134). Stress above one or more of the limiting values may cause permanent damage to the device. These are stress ratings only and operation of the device at these or at any other conditions above those given in the Characteristics sections of this specification is not implied. Exposure to limiting values for extended periods may affect device reliability.	
Application information	
Where application information is given, it is advisory and does not form part of the specification.	
© Philips Electronics N.V. 1996	
All rights are reserved. Reproduction in whole or in part is prohibited without the prior written consent of the copyright owner.	
The information presented in this document does not form part of any quotation or contract, it is believed to be accurate and reliable and may be changed without notice. No liability will be accepted by the publisher for any consequence of its use. Publication thereof does not convey nor imply any license under patent or other industrial or intellectual property rights.	

LIFE SUPPORT APPLICATIONS

These products are not designed for use in life support appliances, devices or systems where malfunction of these products can be reasonably expected to result in personal injury. Philips customers using or selling these products for use in such applications do so at their own risk and agree to fully indemnify Philips for any damages resulting from such improper use or sale.